

# AutoSkim™ Skimmer - Hayward®

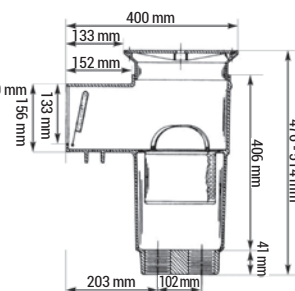

SP1082

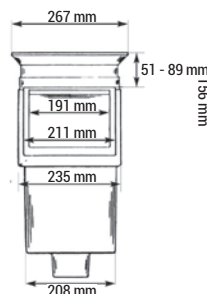
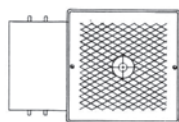

SP1084

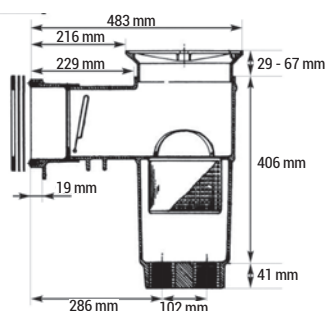
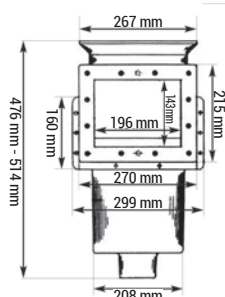
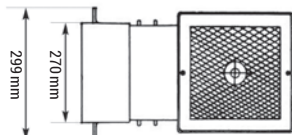

SP1085

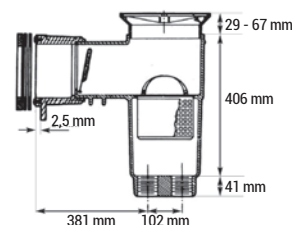
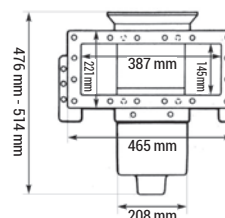
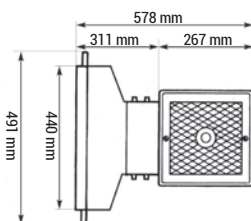

SP1094WF

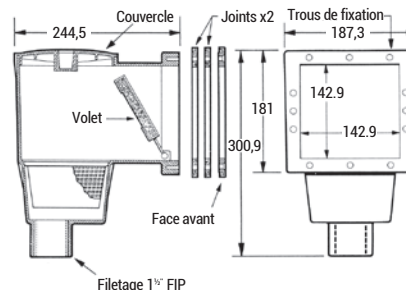
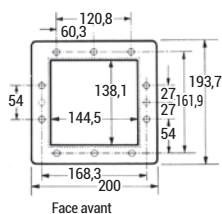

AUTOSKIM™  
SKIMMER HAYWARD®

DYNA SKIM SERIES

Beschreibung	Maß Wanddurchführung	Ref. Beton	Ref. Folie
Gerader Skimmer	129 mm	SP1082	-
Skimmer kleine Saugöffnung	229 / 229 mm	SP1084C	SP1084
Skimmer große Saugöffnung	325 / 253 / 325 mm	SP1085C	SP1085
Paket lange Schrauben 32 mm	-	-	SPX1085Z1AM
Skimmer Folie Dyna Skim und Skim Vac	-	-	SP1094WF