

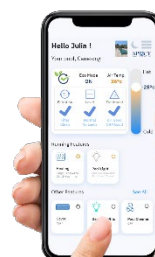

SPACE

SWIMMING POOL AI. CLOUD EXPERT

Installation guide



SECTION 1 INSTALLATION GUIDE

1.0	USING AND SETTINGS.....	3
2.0	MENUS	4
3.0	MANUAL CONTROL	5
4.0	FILTRATION MODES	6
5.0	AUXILIARIES	7
6.0	WATER AND TREATMENT.....	11
7.0	MAINTENANCE.....	12
8.0	CONFIGURATION	13
9.0	SPACE CLOUD.....	14
10.0	CIRCULATION MODE (WITH AUTOMATIC SUCTION VALVE).....	14

Section 2 PROGRAMMING GUIDE

4.1	FILTRATION MODES MENU	15
5.1	AUXILIARIES MENU	16
6.0	WATER AND TREATMENT	18
6.1	WATER LEVEL CONTROL	18
6.2	pH CONTROL	22
6.3	ORP CONTROL	23
6.4	REMNANT INJECTION (H ₂ O ₂)	24
6.5	ACO INJECTION	25
6.6	FREE CHLORINE PROBE CONFIGURATION	26
7.0	MAINTENANCE	27
7.1	MAINTENANCE TOOLS.....	
7.2	pH, Free chlorine, Conductivity Calibration.....	
7.3	SENSORS REPLACEMENT	
8.0	CONFIGURATION MENU	32
8.1	Pool data	32
8.2	Pump configuration.....	33
8.3	Filter data	35
8.4	CONFIGURING INPUTS	37
8.5	FACTORY SETTINGS.....	39
8.6	EQUIPMENT.....	40
8.6.1	POOL COVER	40
8.6.2	JETSTREAM.....	41
9.0	SPACE Cloud.....	42
10.0	CIRCULATION MODE (WITH AUTOMATIC SUCTION VALVE).....	44
11.0	SCHEMATIC DIAGRAMS FOR SKIMMER & OVERFLOW POOLS.....	46

1. Using and settings

BACKLIGHT

Pressing any button illuminates the backlight.

The backlight remains on for 3 minutes.

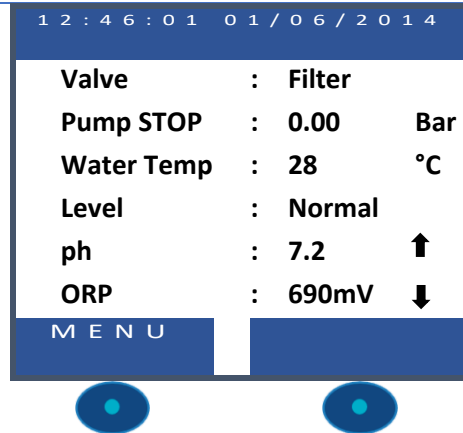

Navigate the SPACE menu

- ❑ Press the **MENU** button.
- ❑ **SPACE MENU** is displayed.
- ❑ Use the **UP** and **DOWN** buttons to choose the submenu (in this case Manual Control), then press **SELECT** to go to that submenu.

Repeatedly pressing **QUIT** to return to the main display.

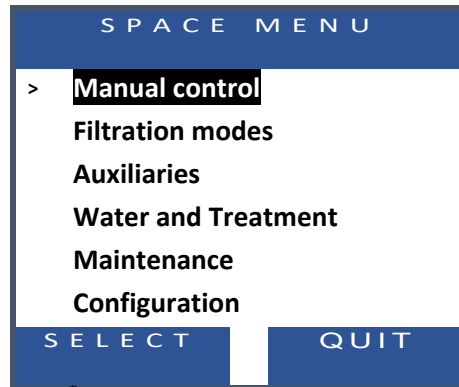

Return to Main Display

When viewing any menu screen:

- ❑ Press **QUIT** to go up one menu level.
- Every display has a 15 second timeout to go back to the previous menu. The display will timeout to the main display within approximately 1 minute.

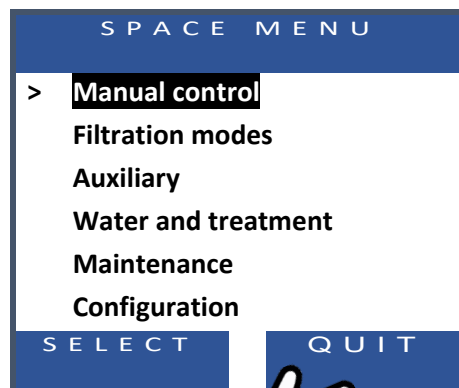

2. Menus

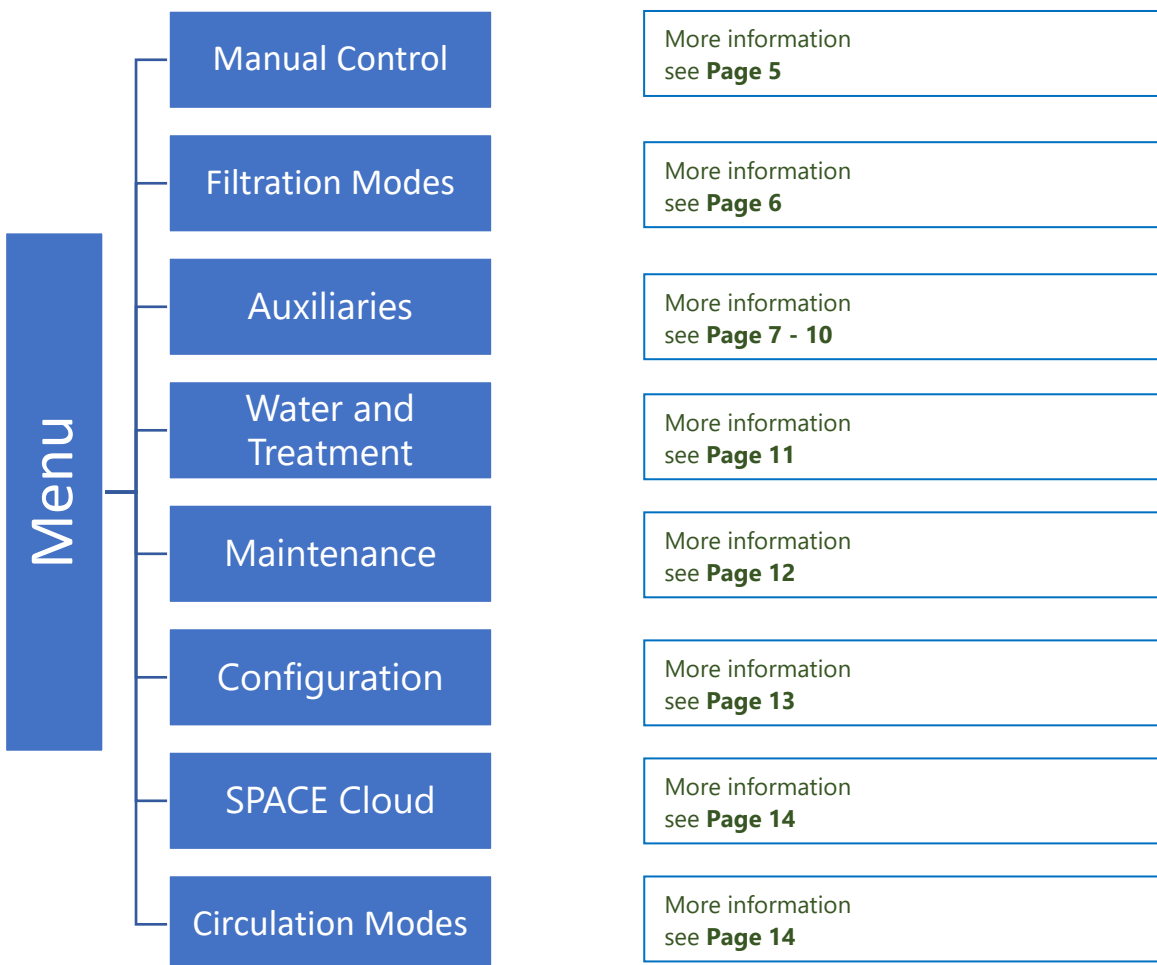

3. Manual control:

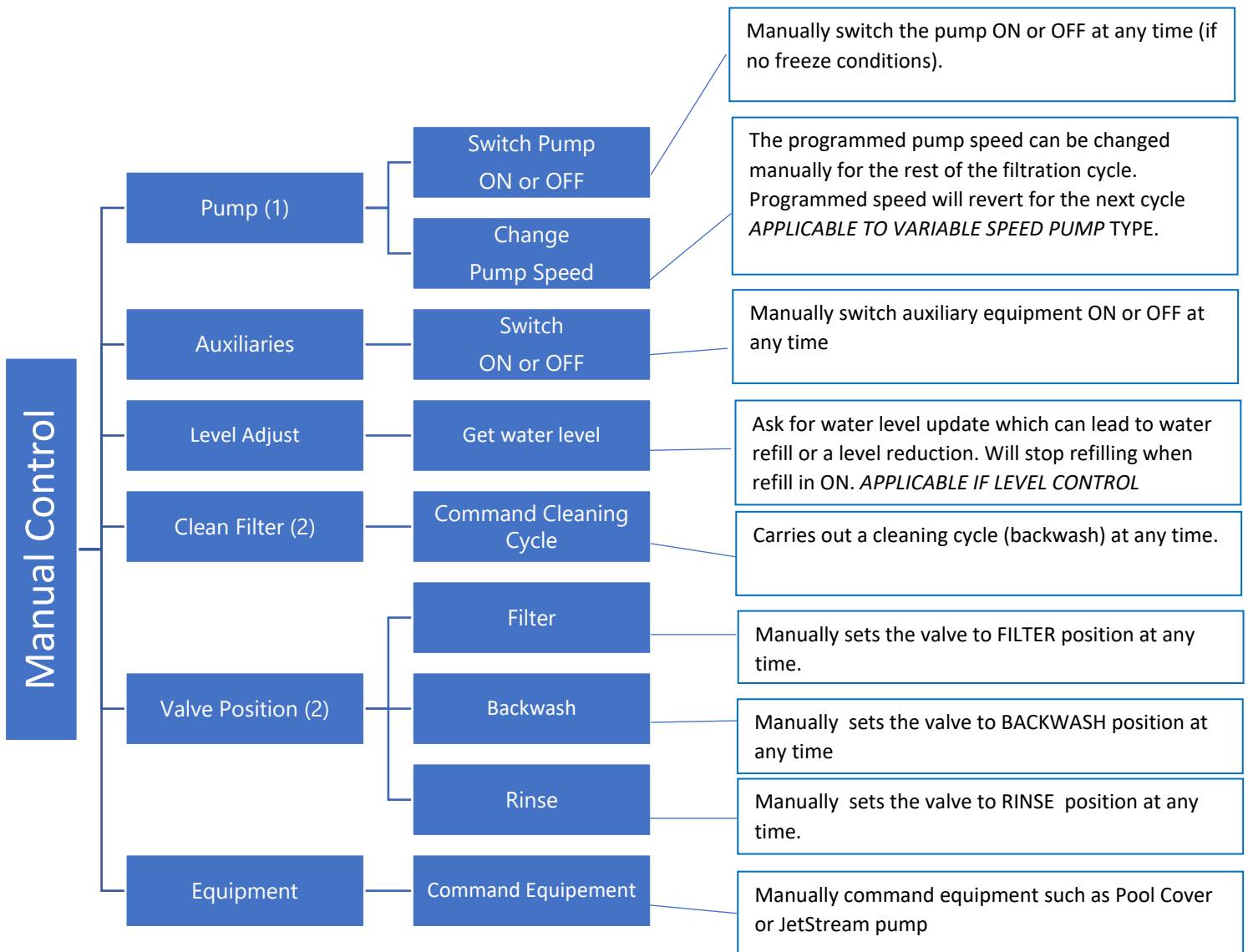

- (1) Not available of Filtration set in **NOPUMP** Mode
- (2) Not available when cleaning valve is not configured
- (3) Not available when rinse valve is not configured

4. Filtration modes :

See page 15

Filtration Modes	Stopped	Cycle1 =00:00-00:00 Cycle2 =00:00-00:00	Filtration is stopped. Both Cycle1 and Cycle2 timers are set to 00:00-00:00.
	Timer	Cycle1 =xx:xx-xx:xx Cycle2 =xx:xx-xx:xx	Cycle1 and Cycle2 are free to be set at any value you may choose. Make sure there is at least 30 min break between Cycle1 and Cycle2.
	ECO+	Cycle1 =xx:xx-xx:xx Cycle2 =xx:xx-CALC	Cycle1 is free to be set at any value you may choose. Choose Cycle2 start time, duration is calculated in accordance with pool needs based on temperature. Cycle1 duration is taken into account.
	Volume	Cycle1 =xx:xx-xx:xx Cycle2 =xx:xx-CALC	Cycle1 is free to be set at any value you may choose. Choose Cycle2 start time, duration is calculated in accordance with pool needs based on turnovers. Cycle1 duration is taken into account.
	Continuous	Cycle1 =xx:xx-CALC Cycle2 =CALC-CALC	Choose Cycle1 start time. Cycle1 and Cycle2 duration are 11:30min fixed value allowing a 23 hour per day filtration duration.
	Force 24H	Cycle1 =CALC-CALC Cycle2 =xx:xx-yy:yy	Filtration will run 23 hours per day for 24 hours and then revert to normal filtration times. Cycle1 timer settings will be changed when entering the forced mode and restored at the end of period.
	Force 48H	Cycle1 =CALC-CALC Cycle2 =xx:xx-yy:yy	Filtration will run 23 hours per day for 48 hours and revert to normal filtration times. Cycle1 timer settings will be changed when entering the forced mode and restored at the end of period.
	Force 72H	Cycle1 =CALC-CALC Cycle2 =xx:xx-yy:yy	Filtration will run 23 hours per day for 72 hours and then revert to normal filtration times. Cycle1 timer settings will be changed when entering the forced mode and restored at the end of period.
	24/24	Cycle1 =00:00-00:00 V1 Cycle2 =00:00-00:00 - V2	Pump is controlled and will run continuously except if priming is lost. The pH will be read once every hour. Waterlevel every 20 minutes
	NO PUMP		Pump is not controlled by SPACE. When the pump is detected as running features will function automatically.

5. Auxiliaries

SPACE DCCU



Auxiliaries	PUMP	Id	Set ID
		Mode	Set Mode
		ON	Set ON time HH:MM in timer and pulse modes
	Aux 1	OFF/Dur	Set OFF time HH:MM in timer mode, or duration in pulse mode
		Slave	Slave AUX to filtration; the auxiliary will only be ON if the pump is primed
		Day of Week	Set AUX to operate on selected days of the week
		Speed Ctrl	If SPACE controls a multi-speed pump, AUX 1 is not available.
	Aux 2	See Aux1	AUX 2 functionality is the same as AUX 1
		Speed Ctrl	If SPACE controls a multi-speed pump, AUX 2 is not available (is reserved for speed 2)
	Aux 3	See Aux1	AUX 3 functionality is the same as AUX 1
		Speed Ctrl	If SPACE controls a multi-speed pump, AUX 3 is not available. (is reserved for speed 3)
	Aux 4	See Aux1	AUX 4 functionality is the same as AUX 1
		Suction valve	If a suction valve is configured, AUX 4 is not available. (is reserved for the Suction valve)
	Aux 5	Besgo valve	See, Configuration - Filter data – (backwash setting)
		Backwash	(is reserved for the backwash valve)
	Aux 6	See Aux1	See, Configuration – ORP regulation
		ORP	(is reserved for ORP regulation)
	Aux 7	See Aux1	See, Configuration – pH regulation
		pH	(is reserved for pH regulation)

SPACE DCCU - Auxiliaries (outputs)

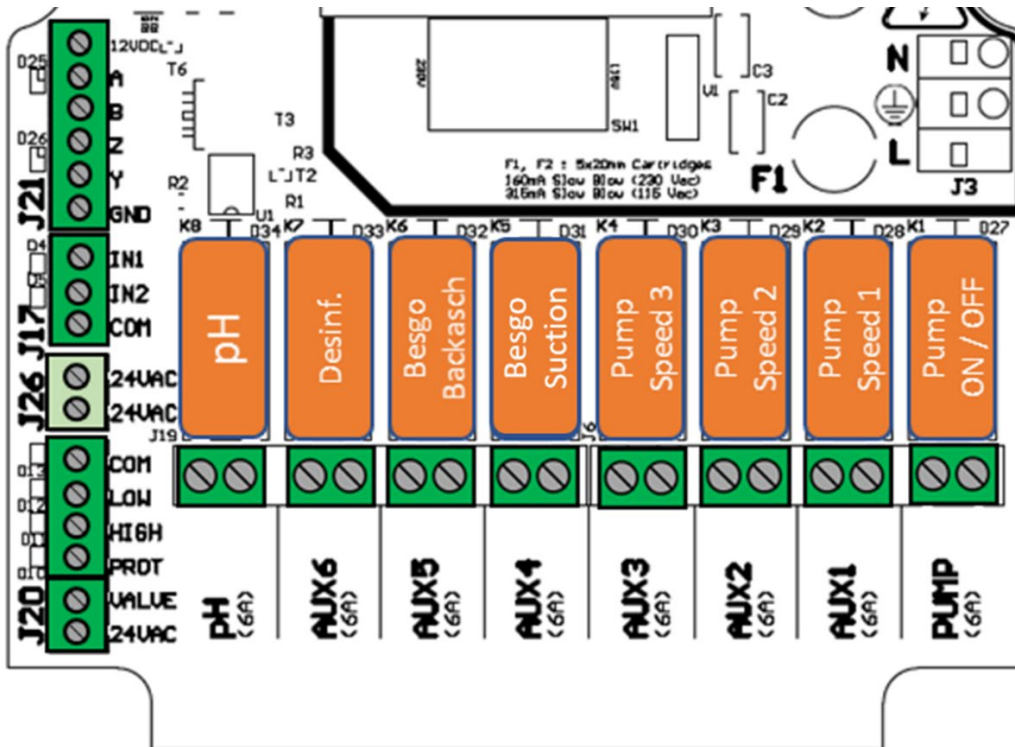

	<u>Output</u>	<u>Function</u>	<u>Default setting</u>	
Standard Outputs	Pump	Relay pump	Pump	Single speed pump configured by default. If a multi-speed pump is declared in the settings, the AUX1, AUX2, AUX3 outputs are automatically assigned to speed control; otherwise AUX1, AUX2, AUX3 are free to use.
	AUX1	Speed 1	Free	
	AUX2	Speed 2	Free	
	AUX3	Speed 3	Free	
	AUX4	Besgo 3-way Suction valve	Free	If a suction valve is declared in the settings, it is automatically assigned to Aux4, otherwise Aux4 is free to use.
	AUX5	Besgo 5-way Backwash valve	Backwash	If a backwash valve is declared in the settings it is automatically assigned to Aux5. Otherwise, Aux5 is free to use.
	AUX6	Disinfection	Disinfection	If ORP disinfection is declared in the settings, the dosage is automatically assigned to Aux6. Otherwise Aux6 is free to use.
	AUX7	pH	pH Minus	AUX7 is reserved in all cases.

Auxiliaries Extension Modules:

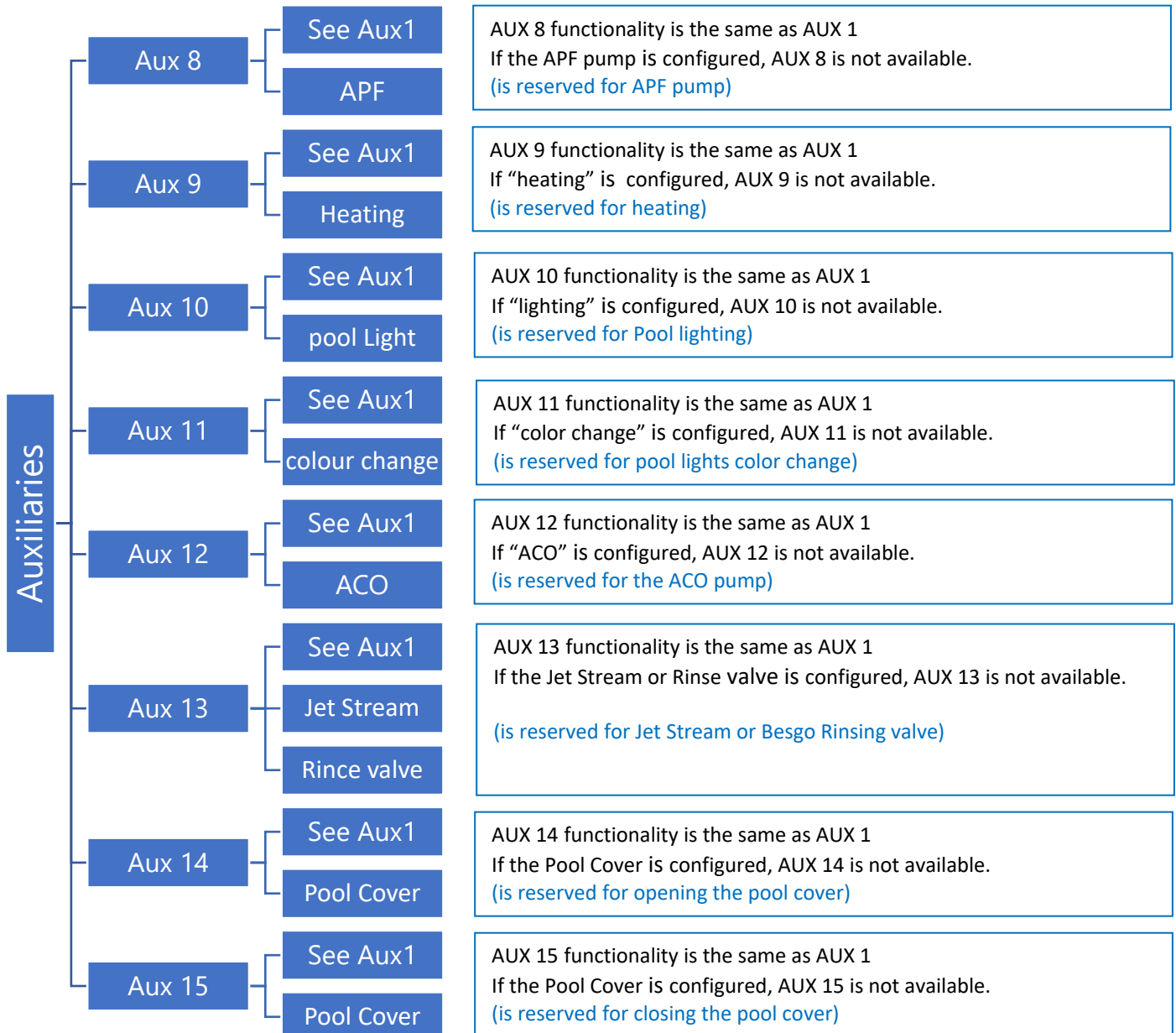

SPACE Extension module

AUX (outputs)

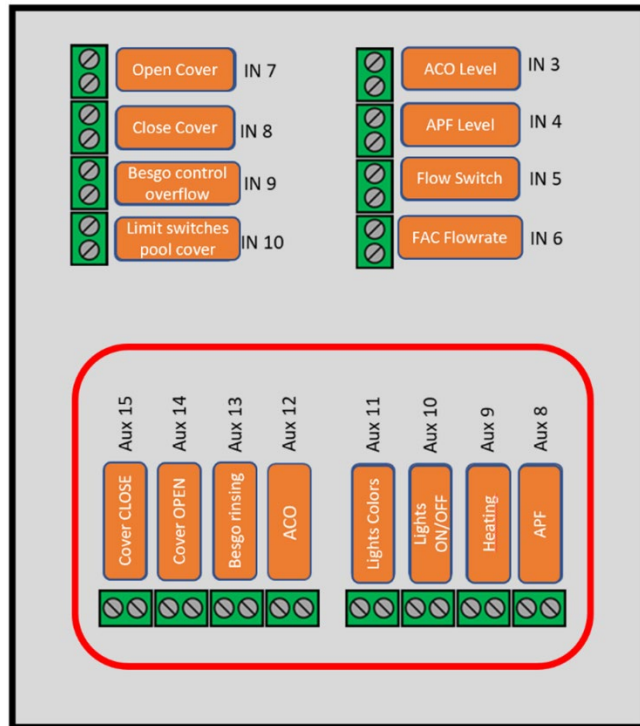

	<u>Output</u>	<u>Function</u>	<u>Default setting</u>	<u>Comments</u>
SPACE Extension Module	AUX8	Dosage APF	APF	If APF is declared in the settings it is automatically assigned to Aux8, otherwise Aux8 is free to use.
	AUX9	Heating	Heating	The heating system can be assigned to any available Aux. It will be assigned to Aux9 by factory setting but can be reassigned.
	AUX10	Pool lights	Pool lights ON/OFF	The lights can be assigned to any available Aux. It will be assigned to Aux10 by factory setting but can be reassigned.
	AUX11	Pool lights	Colour change	The colour change can be assigned to any available Aux. It will be assigned to Aux11 by factory setting but can be reassigned.
	AUX12	ACO	ACO	If ACO dosing is declared in the settings, it is automatically assigned to Aux12. Otherwise, Aux12 is free to use.
	AUX13	Besgo 3-way rinsing valve	Free	If a Besgo rinsing valve is declared in the settings it is automatically assigned to Aux13, in which case Aux13 can no longer be assigned to manage countercurrent jetstreams.
	AUX14	Pool cover	Free	
	AUX15	Pool cover	Free	

6. Water and treatment:

View and adjust various water level and treatment options available.

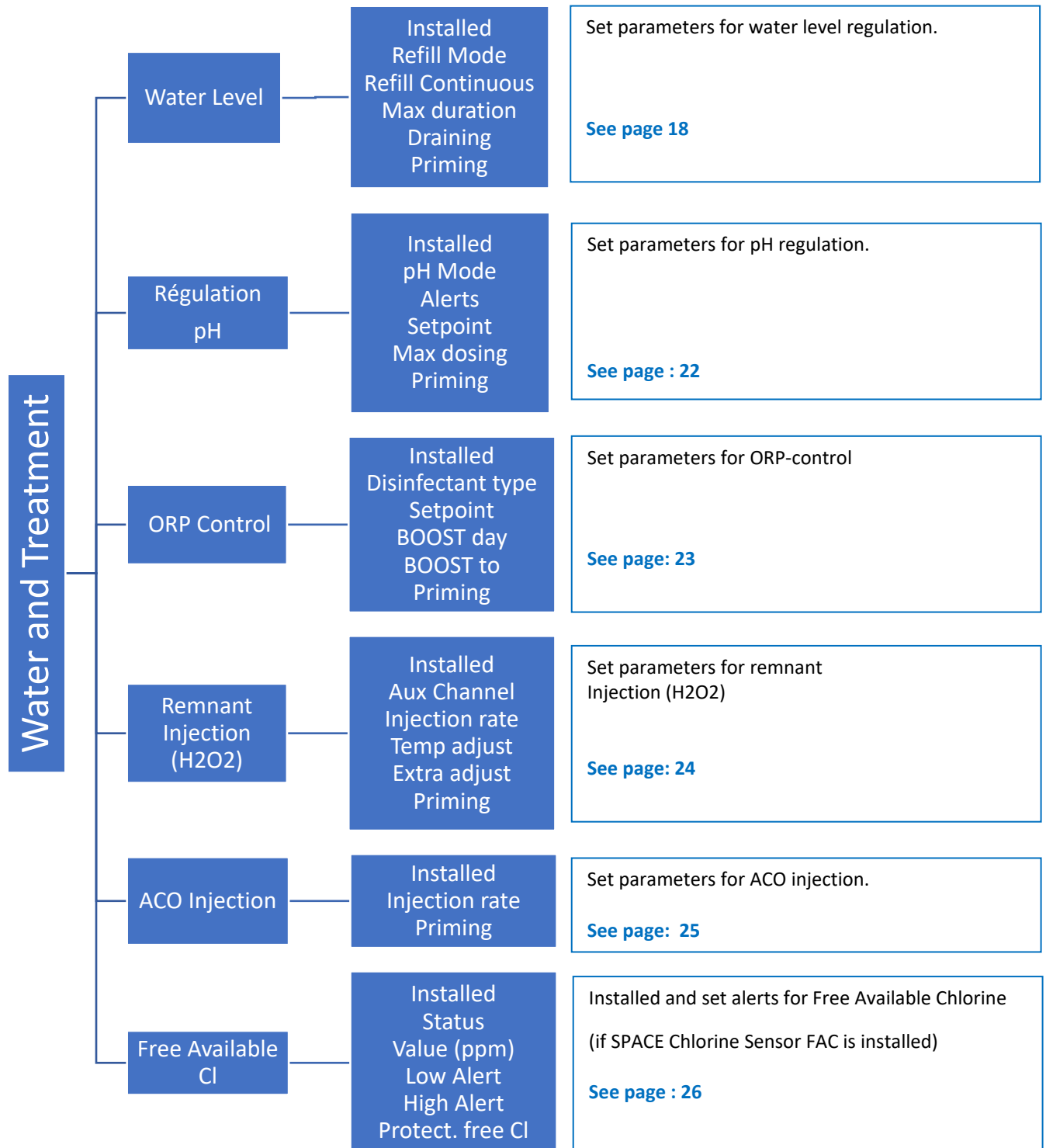

7. Maintenance :

Maintenance	Service Mode	Activate/deactivate service mode.
	Measure pH	Measure pH
	Calibrate pH	Calibrate pH
	Value FAC	Read FAC (if SPACE Chlorine Sensor FAC is installed)
	Calibrate FAC	Calibrate FAC (if SPACE Chlorine Sensor FAC is installed)
	Calibrate Conductivity	Calibrate conductivity (if Space DA-GEN is installed).
	Air Antifrz	Air temperature to start antifreeze protection
	Stop Water Treatmt	Low water temperature to stop water treatment
	Calibrate water temperature	Adjust Water Temperature

For a much easier and faster configuration, we recommend you to do it on pro.dryden-space.com

8. Configuration:

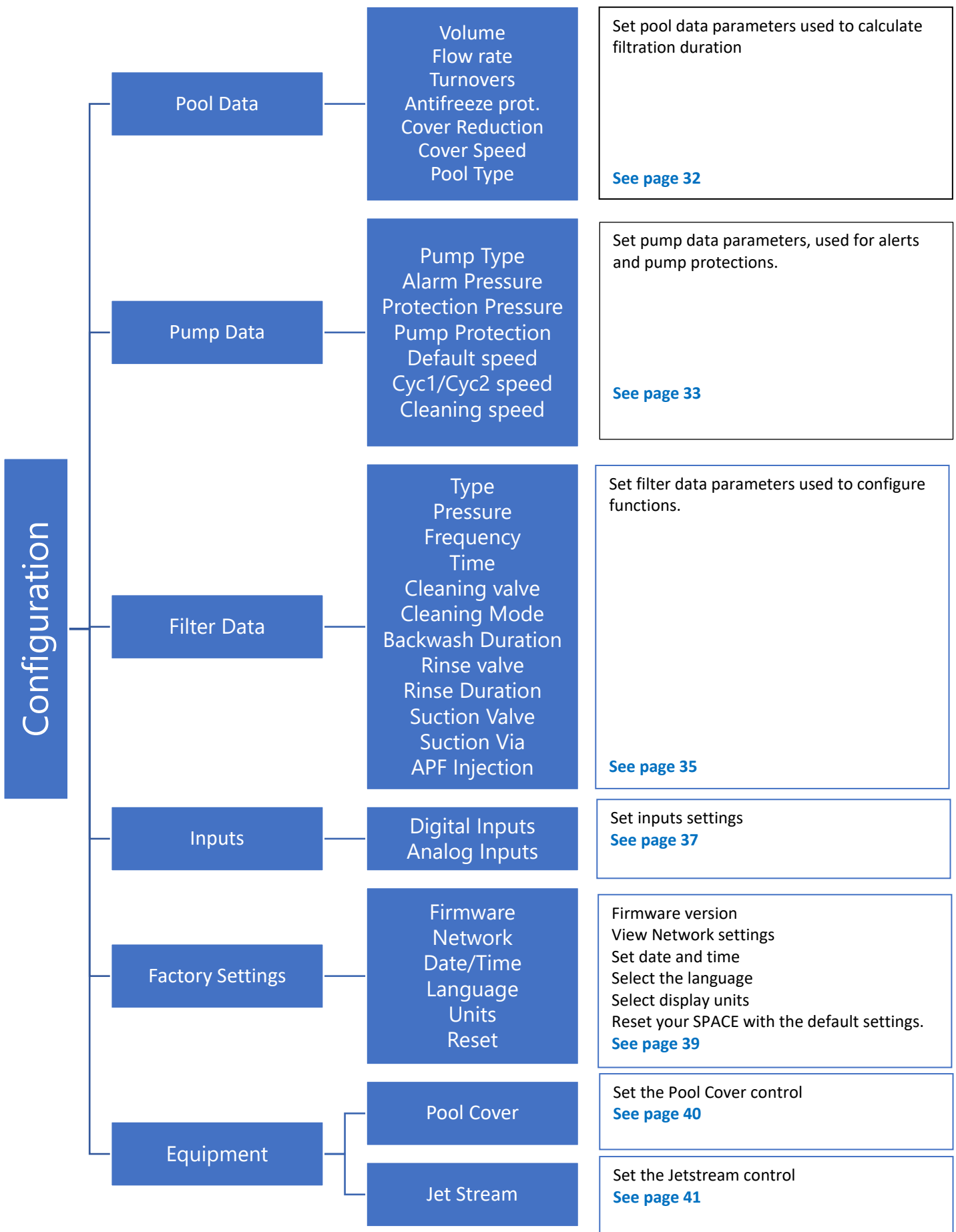

9. SPACE Cloud : See page 40

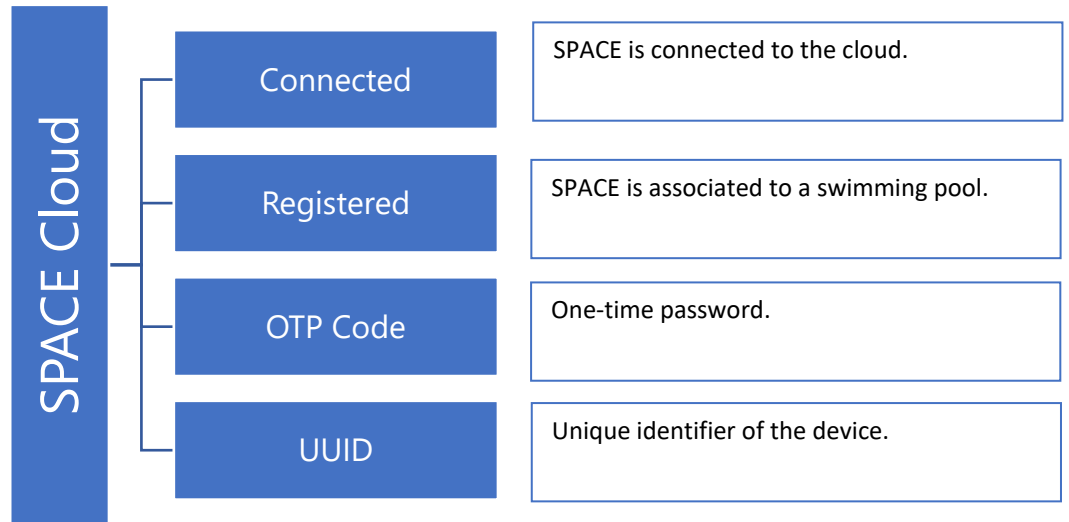

10. Circulation mode: (if suction valve is present)

Specific parameters dedicated to circulation mode.

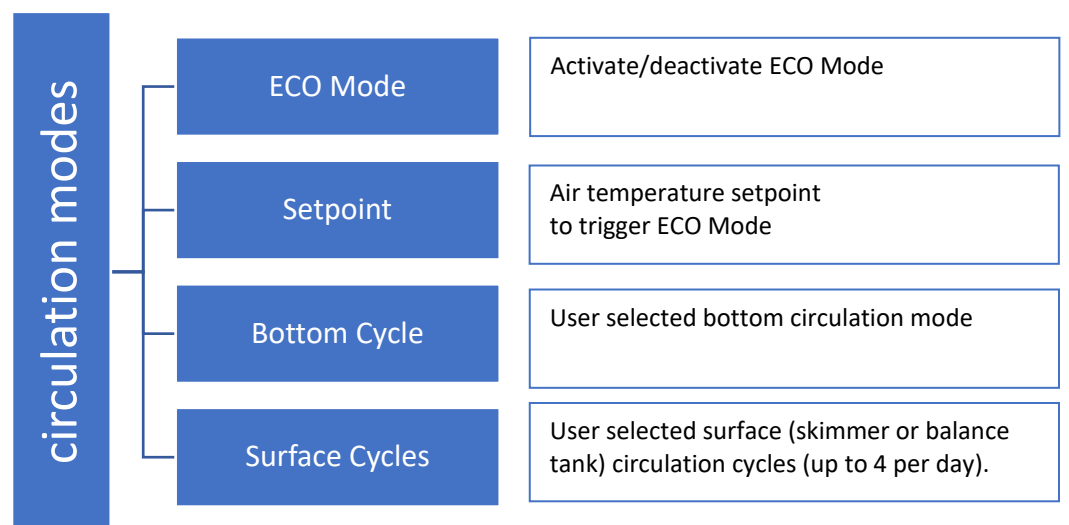

4.1 FILTRATION MODES MENU

Filtration Modes

Text:	
Default:	STOP
Modes:	STOP; TIMER; ECO+; VOLUME; CONTINUOUS; FORCE24H; FORCE48H; FORCE72H; 24/24; NO PUMP

Set the duration and daily filtration times.

The filtration programmer has two cycles over a 24-hour period, Cycle 1 and Cycle 2, these cycles have predefined values or are freely accessible according to the filtration mode chosen.

The filtration programmer has 8 operating modes.

- In **STOP** Mode, filtration timers are set to **00:00** and will remain **OFF** as long as there is no filtration cycle or no manual command to start the pump. The filtration will never run in automatic mode.
- In **TIMER** Mode, Cycle 1 and Cycle 2 are set by the user. SPACE will use fixed programmed timer settings to start and stop the filtration.
Note: It is recommended to keep at least 2x30 minutes of free time (no filtration) per day. This allows pH measurement, periodic filter cleaning, automatic filling of the pool if installed.
- In **ECO+** Mode SPACE adjusts the filtration duration based on measured water temperature, filtration rates, and other factors. This mode allows SPACE to automatically adjust the filtration duration based on changing seasonal and weather conditions and thus protect water when temperature is high and save energy if temperature is low.
 - Set Cycle 1 as desired. Duration will be taken into account when calculating Cycle 2 duration.
 - Set the Cycle 2 Filtration **ON** time. SPACE calculates and sets the **OFF** time, with **X** indicated.
 - The duration is automatically calculated based on the average measured temperatures during filtration in the last 24-hour period.

Note: ECO+ Mode uses the average water temperature, observed over the day. After a reset, the default filtration time is about 8 hours, based on an assumed temperature of 20°C. The first time ECO+ mode is selected, the duration of cycle 2 will be set by default to 8 hours. After about 10 minutes of operation, an accurate measurement of the pool water temperature will allow SPACE to assess the adequate filtration time.

An update will be made automatically at 17:00.

- VOLUME** mode is based on the same model as **ECO+** Mode with a noticeable difference:
 - In **ECO+** Mode, the filtration duration is calculated is made using the pool temperature.
 - **VOLUME** Mode does not take temperature into account, but simply use the turnover rate defined in the Pool data menu to estimate the filtration time.
- In **CONTINUOUS** mode, Cycle1 and Cycle 2 have the same 11:30 duration time so that the global filtration is 23/24. The only available setting is the starting time of Cycle1.
- In **FORCE** Mode (24H, 48H or 72H), the filtration will operate 23 hours a day for the selected period and will then revert back to the previous mode. Forced mode is achieved by temporarily setting Cycle 1 timer value so that, added to Cycle 2, the filtration duration is 23 hours. No timer settings are available in Forced mode.

- In the **24/24** mode, the pump operates continuously, as long as it is primed and the pressure remains ABOVE Protection Pressure. (*pH measurements are done 1x per hour and level measurements every 20min.*)
- In **NO PUMP** mode, SPACE does not control the filtration pump, it is supposed to be controlled externally. Priming and flow control are still monitored.

5.1 AUXILIARIES MENU

Operation Modes of auxiliaries are related to auxiliary names (for those which are free)

Auxiliary timers have one cycle in any 24-hour period.

When quitting the **AUXILIARIES** menu, SPACE checks the status of the auxiliaries, and switches them **ON** or **OFF** as required to match programmed running times.

Auxiliary ID

The default identification is Free. Each auxiliary can be renamed for ease of use and tracking. The following 15 predefined names are available for auxiliaries:

Default: Free
Entries: Available
Pool Light
Pool Cleaner
Pool Heating
Disinfection
Electrolyzer
Remnant
Trans./by-pass pump
UV
Spa
Fountain
Bore Hole
Pool House
Garden 1
Garden 2
Garden 3

Used for :
Values: Used for backwash valve
Used for speed control
Used for ORP control
Used for Remnant (H2O2 dosing)
Used for pool cover
Used for jet stream
Used for alarm signaling
Used for cleaning valve
Used for Rinsing valve
Used forum APF dosing
Used forum ACO dosing
Used for Suction Valve

NOTE:

On "infinity" pools, an auxiliary whose identifier is "Transfer pump" is considered to be the means of moving the water from the buffer tank to the pool. The pump controlled by this auxiliary will be set ON automatically during the water level control phases in order to produce a change on the water level in the buffer tank.

NOTE:

To change the auxiliary ID, use the up arrow to place the cursor in the title area. Then use the up and down arrows to select the ID text and confirm with SELECT.

NOTE:

Each auxiliary can be renamed on the web application for ease of use and identification via remote interfaces. The name is unchanged on SPACE.

"Aux" Mode

Manual mode allows manual **ON/OFF** commands only. No automatic function will apply.

Timer mode allows to define a start time and a stop time.

Pulse mode allows to manage the **ON** duration. When the Aux is set **ON** (manually or automatically) it will revert to **OFF** after the defined duration.

When auxiliary is set as heating, 3 additional modes are available:

In **Filtration** mode, the heater can only operate during programmed filtration hours. This is our recommendation.

In **Priority** mode, the filtration pump is forced on for priority heating which will accelerate the increase of water temperature.

In **Schedule** the operation of the heater is limited within the period defined by its own timers. Heating will then only be possible within the defined **ON/OFF** time range and if the filtration is running.

Text:	Mode
Default:	Manual
Entries:	Manual; Timer; Pulse; Filtration; Priority; Schedule

The table below summarizes the available modes according to the auxiliary's identifier:

	Available	Pool Light	Pool cleaner	Pool Heating	Disinfection	Salt System	Remnant	Transfer Pump	UV	Spa	Fountain	Bore Hole	Pool House	Garden 1	Garden 2	Garden 3
Manual		X	X	X	X	X	X	X	X	X	X	X	X	X	X	X
Timer		X	X		X	X	X	X	X	X	X	X	X	X	X	X
Pulse		X	X		X		X			X	X	X	X	X	X	X
Filtration				X												
Priority				X												
Schedule				X												

"AUX" Times (Timer mode)

In **Timer** mode, set fixed duration with **ON** and **OFF** times.
Setting any timer to 00:00-00:00 deactivates that timer.

Text:	ON/OFF
Default:	00:00-00:00
Entries:	00:00-23:59

"Aux" Time and Duration (Pulse Mode)

In **Pulse** mode, define the ON time.

ON time set to 00:00 suppresses automatic pulse generation. Aux must be set **ON** manually and will fall back to **OFF** automatically after pulse duration.

When in **Pulse** mode, define the duration, up to 99 minutes and 59 seconds.

Text:	ON
Default:	00:00-00:00
Entries:	00:00-23:59
Text:	Duration
Default:	00:00:00
Entries:	00:00:00-00:99:59

"Aux" heating temperature (Filtration/Priority/Schedule modes)

Set the desired temperature of water.
The temperature will be maintained ± 0.1 °C (± 0.18 °F) of the set point.

Text:	Temp
Default:	25°C (77°F)
Entries:	2°C to 40°C (35.6°F to 104°F)

"Aux" Slave

Auxiliaries can be set to run only if:

- The pump is primed (**SLAVE: PUMP**). This is essential for equipment requiring a water flow, such as a robot, water treatment, etc.
- The cover is open (**SLAVE: COVER**). This function only applies to the pool light and JetStream.

Text:	Slave
Default:	NO
Entries:	NO; Pump; Cover

"Aux" days of the week

Auxiliaries can be set to run only on selected days of the week.
This is ideal for equipment such as pool cleaners and irrigation, which can be run on specific days of the week.

Text:	Weekday
Default:	ON (ALL)
Entries:	Mon; Tue; Wed; Thu; Fri; Sat; Sun

6.0 Water and treatment:

6.1 Water Level Control

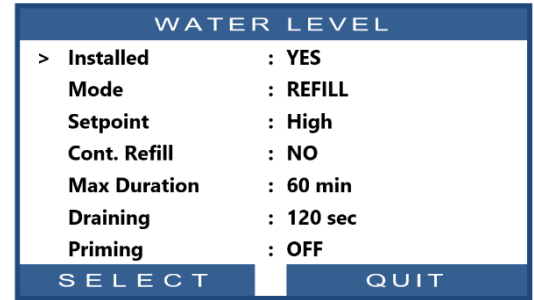

Set water level control parameters.

SPACE can be configured to automatically refill water level.

Installed:

Select this checkbox if a water level sensor is connected. This will allow the measurement and indication of the water level. This will also allow manual control to fill the pool. Manually controlled filling stops automatically when the water level is detected **HIGH**.

Mode:

In Timer mode: Water level control is performed only when the pump is stopped and updated every 15 minutes. The change of a parameter setting will be considered during the update, within a maximum of 15 minutes after the change.

Automatic Refill or Mode=REFILL:

Check the "automatic refill" box or choose "mode=REFILL" to enable automatic refills.

The water level is checked within 15 minutes after pump is stopped at the end of the filtration cycles, an automatic refill is activated if the level is LOW.

In 24/24 mode :

The level is checked and controlled every **20 minutes** outside of disinfection dosing periods. Water refill can start immediately but will be interrupted after 30 minutes. If the set water level has not been reached during this time period, refill will start again in the **next 20 minutes**. Multiple refill periods can be used to reach the set level. The adjustable maximum refill time is always in place to protect against leakage.

A water level/refill control will be carried out systematically **after every filter backwash (and rinsing)**.

At the end of a filter backwash, the water level is checked and readjusted (if water refill is possible). To take into account infinity pools and possible level fluctuations in the buffer tank, water refill can be repeated up to 6 times with a delay of 20 seconds between each water level measurement. Refills stop as soon as the level stays at its set point.

The frequency of water level reading will be increased after backwashing and repeated several times.

The logic that immediately follows a filter backwash is as follows:

1. Launch water level adjustment
2. If the level is LOW, suction is done via the bottom drain
3. Refills if necessary
4. At the end of refill, the suction valve can be switched back to the surface (skimmer or buffer tank)
5. At the end of the refill wait 20 seconds.
6. Steps 2,3,4,5 can be repeated up to 6 times.

To obtain a good repeatability of the final water level, it is recommended to:

Skimmer pools

Do not place the level sensor in the skimmer but on the water line (because the water level is always a bit dropping while skimming). You could place the sensor in the cover niche). This way, the level is independent of the state of filtration (on or off).

Infinity / overflow pools

Leave sufficient space between the target level and the safety-overflow of the buffer tank to accept the excess water that will flow into the buffer tank when the filtration stops.

Continuous mode: (not necessary in 24/24 mode)

Normally, water refill stops when the pump starts. The goal is to avoid overfilling the pool due to incorrect detection of water level due to the movement of water generated by the pump, especially if the sensor is installed inside the skimmer. In some pools, the refill time is longer than the period during which filtration is not in operation, especially in summer time. In this case, and if the water level is not affected by the pump, selecting the continuous mode allows you to keep refilling the pool even if the filtration restarts.

Careful! Check with your installer that this option is appropriate to avoid excessive pool refills, flooding and excessive water consumption.

Maximum duration:

The maximum duration is a method of limiting the duration of each individual refill.

If water refill is not completed by the end of the maximum time, it is stopped and an alarm is triggered.

This is an indication of a possible leak in the system.

Note :

In 24/24 mode: the system will restart refill at 00:00, and this 3 times in a row, if the alarm is not deleted in the meantime. Deleting the alarm allows another 3 successive refills attempts.

Automatic level reduction or Mode=REDUCE:

When the level is VERY HIGH, level reduction cycles (up to a maximum of three per day) are automatically controlled to reduce the water level.

The reduction will be done by cleaning the filter (if the filter cleaning mode is on "Automatic"), but can also be done by directing the water to the sewer (cleaning mode "Manual" or "Inhibited" in the case where a rinse valve is configured).

The reduction of the level is not immediate and depends on the type of pool declared in the pool data:

- With "classic" pools, the level must be detected VERY HIGH during 15 minutes before the reduction is activated.
- With "infinity" pools, the detection of the VERY HIGH level causes the filtration to start and to overflow. If, after 15 minutes, the level remains VERY HIGH, then the reduction is activated. If the level is HIGH, the filtration continues to work. If the level remains HIGH after 3 hours then the reduction is activated. At any time, as soon as the level becomes NORMAL or LOW, filtration is stopped or go to Eco Mode in a 24/24 operation.

Note:

The "Mode=Auto" combines the actions of "Mode=REFILL" and "Mode=REDUCE".

Priming (Solenoid valve Test)

Ensure Solenoid valve is correctly connected and powered. Commanding priming ON will activate the solenoid valve for 60 seconds allowing the water to flow. Priming is stopped when quitting the menu or after 60 seconds.

Refill rate:

Set the actual or estimated average refill rate in cubic meters per hour per minute to allow the calculation of water consumption, displayed in the statistics.

Setpoint

Define the targeted level during refill.

- Normal:** the second slot of the sensor is targeted

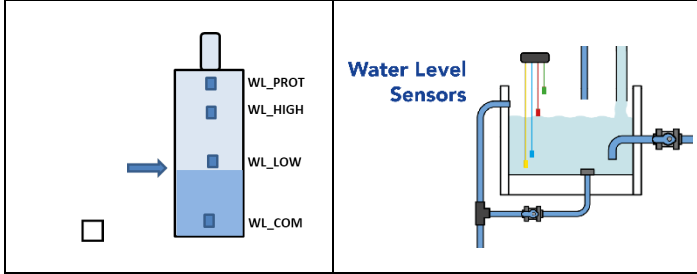

- High:** the third slot of the sensor is targeted

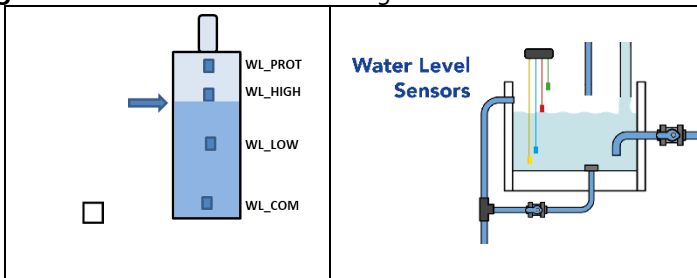

Text:	Setpoint
Default:	High
Entries:	High; Normal

Installation of the water line version, with 4 Terminals

- Secure the water level sensor (using stainless steel self-tapping screws, or appropriate adhesive) at the correct height on the inside of the skimmer or on the waterline.
- If the level sensor is fitted in the skimmer, make sure that the skimmer basket and lid can easily be removed and replaced without damaging the sensor or cable.
- Normal water level must be between WL (HIGH) and WL (LOW).
- WL (HIGH) **must be below pool overflow level** and at an appropriate level with regards to the skimmer.
WL (PROT) is the **V.HIGH** level, at maximum pool water level.

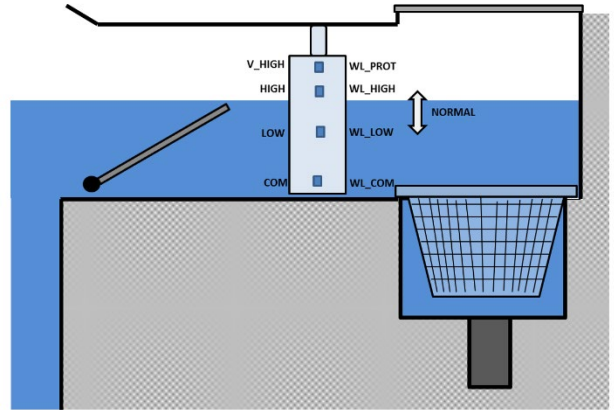

Water line level sensor

PCB Label	TYPICAL Color	ACTUAL Color
COM	Yellow	
LOW	Blue	
HIGH	Red	
PROT	Green	



Installing the Buffer Tank Version, with 4 Sensors (infinity pools)

The 4 sensors have 4 different colours. Use them as in them in the drawing

- Check that the pool water level is correct and that the buffer tank level is correct.
- Secure the 4 water level sensors at the correct respective heights in the buffer tank.
- Normal tank level must be between WL (HIGH) and WL (LOW)
- WL (HIGH) **must be below tank overflow level.**
- WL (PROT) is the **V.HIGH** level, at maximum tank water level.

Water Level Sensors

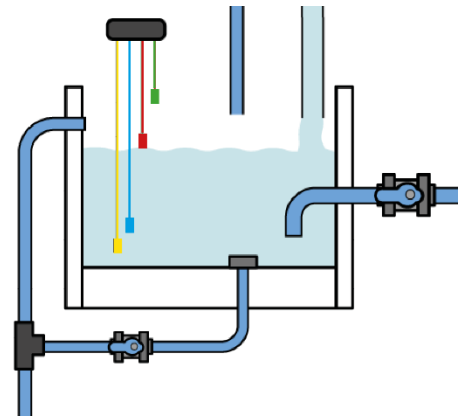

Buffer Tank Water Level Sensors

PCB Label	TYPICAL Color	ACTUAL Color
COM	Yellow	
LOW	Blue	
HIGH	Red	
PROT	Green	

6.2 pH Control

Installed:

Check the box **YES** to activate the function, and allow pH measurement with a pH sensor correctly installed and connected.

Mode:

If your pool is already equipped with a pH control system that works **independently**, you can ask SPACE to simply measure the pH of the water without taking any action to control it. In this case Select **READ**.

Otherwise, select **pH+**, if pH Plus liquid is used or **pH-** if pH Minus liquid is used from the drop-down list, depending on the installation and the type of correction needed.

Careful! Selecting the wrong type of product can result in an over- or under-dosing in the pool.

Setting Low Alert

Allows to define the value to trigger a 'low pH' message.

Setting High Alert

Allows to define the value to trigger a 'high pH' message.

Max Dosing

MAX DOSING acts as a security to prevent inadvertent overdosing, initially calculated with pool volume, can be adjusted. This setting is higher with bigger pools, and with higher water alkalinity; this setting is lower with larger feeder pumps.

MAX DOSING is limited to 15 minutes (per dosing cycle = 60 min) in **24/24** and **NO PUMP** filtration modes.

Setpoint:

Select the desired pH for your pool.

This is generally 7.0 to 7.6, depending on the composition of the water and the water treatment options installed. Note: This set point is defined for water at 24°C, it will be automatically corrected according to the actual water temperature (see below).

Recommended pH setpoint ranges from 7.0 to 7.6 depending on water balance.

Setpoint at Current Temperature

SPACE can automatically adjust the actual pH Setpoint as a function of temperature to ensure year-round optimal water treatment. This adjusted Setpoint is displayed against current water temperature if **TEMP ADJUST** is set to YES. This corrected Setpoint is the actual value of pH the SPACE will aim to maintain.

Temp Adjust

pH setpoint can be auto adjusted by water temperature to respect water balance equilibrium. If set to **YES**, targeted pH setpoint will be in decreased by 0.1 when water temperature increases by 5°C (9°F). If set to **NO**, pH setpoint will not be adjusted.

Note: The temperature adjustment will change the set point. If a stable set point is required, temperature adjustment is not recommended.

Priming (pH pump Test)

Ensure feeder pump is connected to **Aux7** and correctly powered.

Commanding priming ON will activate Aux7 for 60 seconds allowing the feeder pump to prime. Priming is stopped when quitting the menu or after 60 seconds.

pH CONTROL	
> Installed	: YES
Mode	: pH-
Low Alert	: 6.9
High Alert	: 8.2
Max Dosing	: 5 min
SetPoint 24°	: 7.4
SetPoint 18°	: 7.5
Temp Adjust	: YES
Priming	: OFF
SELECT	QUIT

Text:	Mode
Default:	Read
Entries:	Read; pH+; pH-

Text:	LOW Alert
Default:	7.1
Entries:	6.0 to 7.5

Text:	HIGH Alert
Default:	7.7
Entries:	7.5 to 9.5

Text:	Max Dosing
Default:	5+Pool Volume/4 mi
Entries:	1 to 30 min

Text:	SetPoint 24°C (SetPoint 75.2°F)
Default:	7.4
Entries:	6.5 to 8.0

Text:	SetPoint xx °C (SetPoint xx °F)
Display of Data only	

Text:	Temp Adjust
Default:	NO
Entries:	YES; NO

Text:	Priming
Default:	OFF
Entries:	ON; OFF

6.3 ORP Control

ORP measurement-based control allows disinfection management based on actual treatment efficiency.

If a dosing system is connected it must be controlled by the **Aux6 relay**.

Note: As a safety measure, if the measured ORP measurement is less than 100mV, dosing is stopped.

Installed:

If **INSTALLED: YES**, SPACE will control the ORP according to set point value. ORP Control display will be activated; ORP Control Alerts will be activated. If set to **NO**, these functions are deactivated. Default = Yes.

Type of Disinfectant

This defines the type of disinfectant and the algorithms used.

- READ** Read and display only; no control.
- CHLOR** Chlorine dosing.
- SALT** External Salt System control (ex. Topclean)
- BROMI** Bromine dosing.
- OCEAN** For PoolCop Ocean salt chlorinator.
- SPACE** For SPACE-DAGEN hydrolyser.
- DA-GEN** For Dryden Aqua DA-GEN hydrolyser

Set point

Set the desired ORP value, the typical setpoint is 650-720mV. The ideal Setpoint varies with water treatment options, and according to refill water types. **Note: Minimum recommended ORP is 650mV to avoid risk of sensor fouling (biofilm on the sensor)**

Boost on... If hyperchlorination is desired, set the day of the week.
Default = NO

Boost to... If a day of the week is set for hyper-chlorination, set the desired the ORP value. The Boost To value cannot be lower than Setpoint.

Priming (Chlorine pump test)

Ensure feeder pump is connected to Aux6 and correctly powered. Commanding priming ON will activate Aux6 for 60 seconds allowing the feeder pump to prime. Priming is stopped when quitting the menu or after 60 seconds.

With DA-GEN and DA-GEN SPACE hydrolyser, priming is progressive. Display will not go from OFF to ON, but may stay for a while in '...'. This just shows that production has been requested, and is ramping up. When the ramp up is achieved, display should go to 'ON'. If it is not the case, please see diagnostics below.

ORP CONTROL	
> Installed	: YES
Disinfectant	: Chlor
Setpoint	: 760 mV
Boost on	: Mon
Boost to	: 760 mV
Priming	: OFF
Ocean Diag	
SELECT QUIT	

Text:	Installed
Default:	NO
Entries:	YES; NO

Text:	Disinfectant
Default:	Read
Entries:	Read; Chlor; Salt; Bromi; Ocean; Space; DA-GEN

Text:	Setpoint
Default:	760mV
Entries:	300 to 990mV

Text:	Boost On
Default:	None
Entries:	None; Mon; Tue; Wed; Thu; Fri; Sat; Sun

Text:	Boost To
Default:	760mV
Entries:	Setpoint... 990mV

Text:	Priming
Default:	OFF
Entries:	ON; OFF

6.4 Remnant injection (H2O2):

REMNANT INJECTION	
> Installed	: YES
Aux Channel	: Aux2
Inj. Rate	: 1.5 l/h
Temp adjust	: YES
Extra adjust	: Med
Priming	: OFF
SELECT	
QUIT	

Remnant, such as hydrogen peroxide can be injected on a volume basis and temperature.

If this option is enabled, the injection time will be calculated so that the injection ends one hour before filtration.

Set Remnant parameters.

If possible, Remnant will be injected 1 hour before the end of the latest filtration cycle of the day. If there is no filtration cycle long enough, the longer cycle will be chosen.

When Filtration Mode is **24/24** or **NO PUMP**, injection will be set so that it ends at 10PM and re-calculated each day at midnight

Installed

If **INSTALLED: YES**, SPACE will control the Remnant injection according to parameters settings.

If set to **NO**, this function is deactivated.

Aux Channel

Define which auxiliary channel will be used to inject remnant.

Injection rate

Set the feeder pump injection rate. Combined with pool volume (**POOL DATA** menu), the injection rate will be used to calculate the remnant injection duration based on a dosage of **2 ml / m3 / day of pure remnant** product. The calculation is done for H2O2 @ 35%. If you have only 11.9% of H2O2 concentration, reduce the injection rate setting by a factor of 3 (0.5 if your dosing pump is 1.5l/h)

Temperature adjustment

Choose **YES** if the injected volume has to be corrected according to pool water temperature. If Yes, adjustment occurs between 24°C and 30°C. At 30°C, the injected volume is 2 times higher.

Extra adjustment

Add an extra adjustment parameter applying a coefficient to the calculated volume as follow:

LOW: Coefficient is 0.5 (half the volume, for example for indoor pools)

MEDIUM: Coefficient is 1.0

HIGH: Coefficient is 1.5 (1.5 times the volume, for high consumption pools)

Priming (H2O2 pump test)

Commanding priming **ON** will activate the Aux channel for 60 seconds allowing the feeder pump to prime. Priming is stopped when quitting the menu or after 60 seconds.

Text:	Installed
Default:	NO
Entries:	YES; NO

Text:	Channel
Default:	Any available channel
Entries:	Aux1, etc.

Text:	Inj. Rate
Default:	1.5 l/h (9.5 GPD)
Entries:	0.1 to 9.9 l/h (0.63 to 62.8 GPD)

Text:	Temp. Adjst
Default:	YES
Entries:	YES; NO

Text:	Extra Adjust
Default:	Med
Entries:	Low; Med; High

Text:	Priming
Default:	OFF
Entries:	ON; OFF

6.5 ACO injection:

ACO® is a natural stabiliser replacing the need for Cyanuric acid and is adapted to all types of pool water treatments

ACO INJECTION	
> Installed	: YES
Inj. Rate	: 1.2 l/h
Priming	: OFF

SELECT QUIT

Definition of parameters for ACO.

The injection takes place on **Friday** in the day, the time may vary depending on the filtration cycles:

- In **24/24** or **SS_POMPE** mode, the injection will be activated at 1pm.
- In other modes, the injection will take place between 8 a.m. and 6 p.m. subject to a filtration period long enough to allow the injection.

ACO injection is only possible with the SPACE Extension Module, the dosing pump **MUST** be wired to **AUX 12**.

Installed

If **INSTALLED: YES**, SPACE will control the ACO injection according to parameters settings.

If set to **NO**, this function is deactivated.

Injection rate

Specify the injection rate of the dosing pump in liters/hour.

Combined with the volume of the pool (**menu POOL DATA**), the injection rate will be used for the calculation of the injection time based on a dosage of **25 ml/m3/week**. (2.5 l/100m3/week)

Priming (ACO pump test)

Commanding priming **ON** will activate the Aux channel for 60 seconds allowing the feeder pump to prime.

Priming is stopped when quitting the menu or after 60 seconds.

6.6 Free Chlorine Probe Configuration

Free Chlorine measurement available in PPM using SPACE FAC Sensor allows the measurement and historization of available Free Chlorine values, as well as triggering alerts if the rate is LOW or HIGH. This option requires the SPACE FAC PPM sensor add-on.

Installed
Status
Value (ppm)
Low Alert
High Alert
Protect. free Cl

Installed:

The checkbox is checked if a sensor is properly connected.

Modbus ID:

Unique sensor identification on the **ModBus network**. Default ID =**241**.

Serial Number:

Displays the serial number of the sensor.

Status:

Current status of the sensor. OK is displayed if the sensor is working properly.

Update:

Date and time of the last data received from the sensor.

Calibration value:

Displays the correction coefficient applied to the "raw" value.

Low alert:

The value in ppm that triggers the low alert.

High alert:

The value in ppm that triggers the high alert.

Free chlorine protection:

Disinfection is primarily regulated via the redox value, as this leads to more efficient dosing (only as much chlorine as necessary to achieve the hygiene parameter redox). The free chlorine measurement is used to ensure that when the chlorine value exceeds or falls below the legally limit values for free chlorine are maintained. The redox value controls the disinfection until the free chlorine value approaches the limit value. Then the chlorine measurement takes over the control and thus guarantees compliance with the limit values. **This intelligent control reduces the chlorine consumption: Only as much as necessary!**

For more information see " **Free Chlorine Probe Manual Available**" FCC: **44FR.1**

7.0 Maintenance:

Specific parameters dedicated to pool maintainers.
 In **service mode**, SPACE stops all its automatic actions.
 Every connected device (pump, Auxiliaries, water refill...) is stopped when using this mode.
 SPACE will only respond to manual command.
 This mode could be used for passive winterization or during maintenance actions.

MAINTENANCE	
> Service Mode	: NO
Measure pH	: 7.7
Calibrate pH	: 0.1
Value FAC	: 3.2
Calibrate FAC	: 1.2
Calibrate Conduct	: 200uS
Salt Level	: 2.5
Air AntiFrz.	: 5°C
Stop treatmnt	: 12°C
Calib T° (=)	: 28°C
SELECT	QUIT

Measure pH

Perform an extra pH measurement.
 The filtration pump must be stopped to allow measurement.
 (except in **24/24** or **NO PUMP** modes)

Calibrate pH

Allows you to perform a pH Sensor calibration.
 Performs pH sensor calibration.
 The calibration procedure is described below page 27.

CALIBRATION	
Check TAC >80 ppm	
Ref : 7.00	
Confirm Ref	
Then press	
SELECT to calibrate	
SELECT	QUIT

NOTE:

If alkalinity is NOT AT LEAST 80 ppm, pH calibration and measurement will be unreliable.

Ensure that alkalinity is correct, and the body of water is adequately mixed, before calibration.

During the calibration process, SPACE compares the "offset" of the probe to the signal that would be delivered by a perfect probe. This offset is essentially related to sensor aging.

If the offset is too large, calibration is not possible.

It is then necessary to check that the reference pH is correct.

If this is the case, the probe must be replaced.

Value FAC (Free Available Chlorine)

Requests an immediate update of FAC value instead of waiting next polling (within 30 seconds).
 This menu is detailed in **SPACE Chlorine Sensor FAC Installer and User Manual**.
 Please refer to this manual for menu details.

Calibrate FAC

Performs a FAC calibration against a DPD1 analysis.
 This menu is detailed in **SPACE Chlorine Sensor FAC Installer and User Manual**.
 Please refer to this manual for menu details.

Calibrate Conductivity

Allows calibration of the conductivity probe if DA-GEN SPACE and conductivity probe are installed

Text:	Calibration
Default:	current value
Entries:	+0 uS to-20000uS

Carry out a calibration procedure for the conductivity sensor.
 Best result will be achieved by calibration the conductivity in micro-siemens.
 Alternatively, calibration can be carried out by entering a salt concentration level in g/l

NOTE:

Calibration using salt level will be less accurate than calibration with measured conductivity.

Air Anti-Freeze

When an air sensor is connected, defines the air temperature value to start antifreeze protection.

Antifreeze protection will begin as soon as the air temperature is below the set value and will stop 1°C above the set value

Text:	Air Antifrz
Default:	-5°C (23°F)
Entries:	-9°C to 9°C (15.8°F to 48.2°F)

Stop Water Treatment

When water temperature decreases some disinfection methods (for e.g. salt systems) are prone to more rapid wear

Choose the temperature value to stop all ORP driven disinfection systems.

Antifreeze protection will begin as soon as the air temperature is below the set value and stops 1°C above

When the temp

Setting the temperature to 0°C, deactivates protection.

Default = 12°C

Text:	Stop Treatment
Default:	12°C (53.6°F)
Entries:	0°C to 18°C (32°F to 64.4°F)

Adjust Water Temperature

Allows you to align SPACE temperature indication to third party equipment like a heat pump by adding an offset to the temperature indication.

The value between parenthesis is the indication of offset.

- < , offset is negative
- = no offset
- > offset is positive..

Text:	Temp
Default:	0.0 (32°F)
Entries:	-9.9°C to 9.9°C (14.2°F to 49.8°F)

Calibration/Cleaning/Replacement of the pH/ORP Sensor

This Maintenance Procedure details the steps to follow to calibrate the pH/ORP sensor using a standard solution, clean it or replace it.

Note:

On site, it is possible to perform an "online" calibration using the measured pH of the pool water as a reference without the need to extract the sensor from its port.

The measuring probes are sensitive to leakage currents. Always ensure that the pool water is properly connected to a good quality earth (<20 Ohms). The sensitive part of the O.R.P. probe becomes contaminated in the presence of metals in the water.

1. pH Calibration

In **MENU > MANUAL CONTROL > PUMP**, turn off the pump.

- If the sensor is new, rinse it in clean water for 5 minutes.
- Immerse the sensor in the buffer solution pH7 and stir for a few seconds.

2 In **MENU > MAINTENANCE > CALIBRATE pH**, request the calibration of the probe at pH7.

- After calibration, SPACE automatically starts a reading.
- If the pH is unstable or calibration impossible, replace the sensor such as described below:

3 - Remove the probe from the buffer solution pH7.

- - Rinse with clean water.
- - Immerse the probe in the buffer solution pH4 and stir for a few seconds.

4 - In **MENU>MAINTENANCE> MEASURE pH**, ask for the pH reading.

- - If the pH is stable and below pH 4.5, go to step 36 REASSEMBLY, otherwise proceed to the
- cleaning of the probe as described below (CLEANING of the pH cell described in step 5).

5 CLEANING of the pH cell

- - If the pH is unstable or the measurement is not very reactive,
- The cell may eventually be partially clogged.
- - Soak the probe in the cleaning solution for 5 to 10 minutes
- - Repeat the calibration procedure from step 1.
- - If cleaning does not bring improvement, replace the probe as
- described in the **REPLACE** step.

CAREFUL

Make sure you do not damage the metal rod (pH/ORP sensor) during the operation.



ORP PROBE VERIFICATION

- - Immerse the probe in the ORP 470mV buffer solution and stir for a few seconds.
- - On SPACE, when the main screen is displayed,
- - Press the **UP and DOWN** ARROW keys simultaneously to enter maintenance mode.
- - Press the UP arrow until the ORP measurement is displayed.
- - Wait for the measurement to stabilize, it can take up to 15 minutes.
- - If the reading is not correct and no cleaning has been done yet, go to the **CLEANING** step of the sensitive ORP part.
- - Otherwise, replace the probe as described in **the REPLACE step**.
- Press the **UP and DOWN** ARROW keys at the **same time** to exit maintenance mode.

CLEANING of the ORP sensitive part

- - The sensitive part of the ORP probe (red circle below) is likely to be contaminated
- by metals in water. In such a case, the ORP probe no longer responds.



- Using a cotton swab impregnated with a slightly abrasive household cleaning product
- Gently rub the metal rod to remove metal oxides.
- Scrub all sides as best you can.
- Rinse the probe thoroughly with clean water.
- Repeat the **VERIFICATION** step.

REPLACEMENT OF THE ORP/pH SENSORS

Stop the DCCU using the stand by button.

Disconnect the probe from the Connection SE Data card

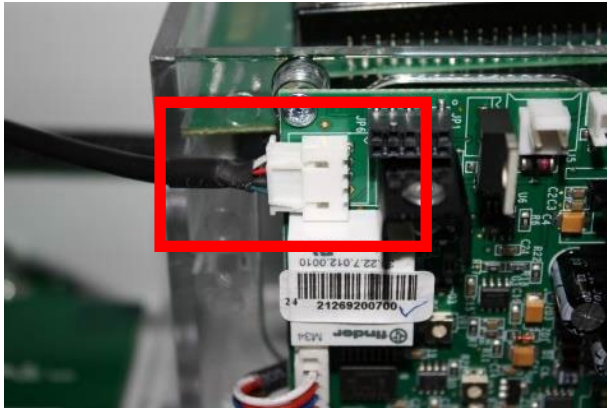

Connect the new probe.

Be sure to follow the pinout.

The probe is delivered with its holding system.

- Make sure that the assembly is done in the following order:

- The retaining nut first
- Next, the anti-slip washer must be located approximately 9-9.5cm from the top of the probe.
- Then the compression washer
- And finally, the O-ring.

- Remove the transport cap.

- Insert the probe into the probe well and hold it in place by tightening the nut.

- Be sure to tighten sufficiently to avoid any risk of leakage.

CAUTION:

Do not over tighten as the probe is a fragile element.

Make sure it is tight enough to avoid any risk of leakage

- Restore the 230V power supply

- Exit the maintenance mode by simultaneously pressing the UP and DOWN arrows.

- Start the pump (**MENU>MANUAL CONTROL>PUMP**).

- When the pump is primed, check that there are no leaks around the probe.

- Let the filtration run for a few minutes.

-

- Stop the pump.

- In **MENU>MAINTENANCE**, ask for the pH reading.

- Check that the pH is stable and representative of the pH of the water.

- In **MENU>MAINTENANCE**, go back to **NORMAL mode**.

8.0 Configuration Menu

8.1 Pool Data

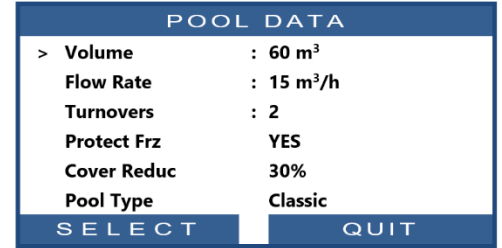
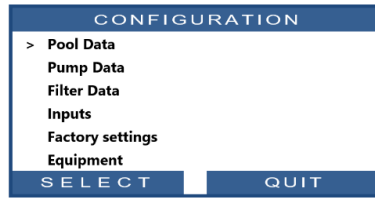

Pool Type:

This parameter is important because it defines the behaviour of the valve and the safety devices. Select the pool type from the drop-down list.

- **CLASSIC** is a standard pool
- **INFINITY** is a pool with an overflow buffer tank.
- **TYPE A** and **TYPE B** refer to the management of the valve position when the pump is stopped:
 - **INFIN. A:** the valve remains in the **FILTER position** when the pump is stopped.
 - **INFIN. B:** the valve is in the **CLOSED position** when the pump is stopped.

Use INFIN. A for Besgo

- **SPA** for small pools or Spas where you do not want to apply hydraulic correction for the calculation of the filtration time.

Text:	Pool type
Default:	Classic
Entries:	Classic; Infini.A; Infini.B; Spa

Pool volume:

Enter the pool **VOLUME** in cubic meters. This is used for filter duration calculations in all automatic modes. Volumes less than 10m³ are considered a spa for filter duration calculations. Hydraulic corrections are not applied.

Text:	Volume
Default:	60 m ³ (15850 USG)
Entries:	1 to 900 m ³ (264 to 237750 USG)

Flow rate:

Enter the **FLOW RATE** of the hydraulic circuit with a clean filter in cubic meters per hour.

This is used for filter duration calculations in automatic modes:

This data is used for filtration and statistical calculations.

- For single-speed pumps, this is the smallest value between pump flow and filter flow.
- When programming for use with a variable speed pump, estimate the average daily flow rate.

Text:	Flow Rate
Default:	15 m ³ /h (66 GPM)
Entries:	1 to 250 m ³ /h (4.4 to 1100GPM)

Turnovers

Set the desired **TURNOVERS** per day.

This is used for filter duration calculations in **VOLUME** mode.

Text:	Turnovers
Default:	2
Entries:	1 to 10

Freezing Protection :

Checking this box activates the frost protection, based on the water temperature and on the indications of an external thermostat if it is installed and configured on an input channel.

Warning! This Freezing protection mode activates the filtration in case of low temperature detection. This feature allows warmer water from the bottom of the pool to circulate and help protect the pool and equipment. This feature cannot guarantee effective frost protection in all pools. This feature does not protect pools where the bottom may be exposed to frost. This feature is used at your own risk.

Text:	Protect Frz
Default:	YES
Entries:	YES; NO

Reducing filtration when the pool cover is closed

a) Filtration Time Reduction (single-speed pump)

Select the reduction percentage you want to apply to the filtration duration (Apply only to **ECO+** mode) when the cover is closed.

b) Pump Speed Reduction (Variable or Multi Speed Pump)

Select the desired pump speed (only applies on **ECO MODE**) when the cover is closed.

This speed will replace the normal Cycle 1 or Cycle 2 preselected speeds as long as the cover is closed.

If value is **0**, no change will occur when the cover state changes.

8.2 Pump configuration

Pump Type:

Determine your pump type: single speed or choose the brand and the variable speed pump model.

Attention! If in doubt or if your pump is not listed, select Single speed pump.

HAYWARD Range VSTD	
> Low Alert	: 0.5 Bar
Prot. Press	: 0.2 Bar
Prot Pomp	: YES
Def. Speed	: 1
Cyc 1 speed	: 1
Cyc 2 speed	: 1
Clean speed	: 1
SELECT	QUIT

Overview pressure parameters

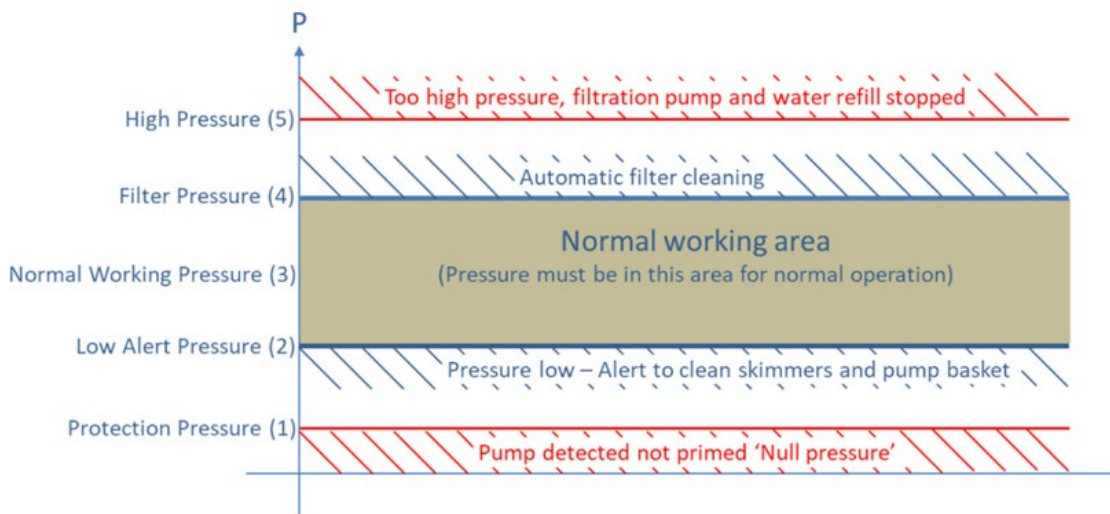

(1) Protection Pressure (very low): Determines if pump is primed or not.

- When pressure is below Protection Pressure, pump is considered not primed.
- Pump protection will be triggered after 8 minutes and stop the pump, if pressure remains below Protection Pressure and if protection is set ON.

(2) Low Alert Pressure (Pump Data): Determines that filter pressure is below the normal range, but water is flowing.

- Pump is considered primed but with low efficiency due low pressure and flow.
- Warning message proposes cleaning skimmer baskets and pump strainer.

(3) Normal Pressure: Determines the normal working pressure range of the pump.

- The pressure must always be within this range during filtration.
- For variable speed pumps, all speeds (except for the backwash speed Nr. 3) must be within this range.

(4) Filter cleaning pressure (under filter data): Determines the pressure at which backwashing is required. If the pressure is permanently at or above this value for 5 minutes, a warning for cleaning the filter is triggered or a backwash is made. – see 8.3

(5) High pressure (fixed value 2.5 bar): Fixed value of 2.5 bar to protect the pump, filter and other equipment in the technical room. In all modes, the pump stops as well as the refilling of the water. A warning message is triggered. The pump does not stop in **No Pump** mode.

(6) Very low pressure (fixed value -0.85 bar): fixed value of -0.85 bar to protect pump, filter and other equipment in the technical room. In all modes, the pump stops and the refilling of the water. A warning message is triggered. The pump does not stop in **No Pump** mode.

How should the setpoints low pressure (message) and protective pressure (stops the pump) be selected?

1. Stop the pump and allow the pressure to stabilize.
2. Note the stopped pump pressure for SPACE:
 1. If the pump is above the water level of the pool, the pressure must be 0 bar.
 2. If the pump is below the water level, there must be a positive residual pressure.
 3. Round up to the nearest number and add about 0.20 bar.
 4. Set this pressure as the protective pressure.

Example

- Pump pressure OFF = 0.15 bar
- Rounded value = 0.20 bar
- Addition + 0,10 bar = 0,30 bar = protection pressure (1)
- Addition + 0,20 bar = 0,40 bar = low alert pressure (2)

Activate Pump Protection = ON:

Activates the pump protection by switching OFF the pump and integrated water treatments, in the event of pressure measured is below the Protection Pressure for more than **8 minutes**.

Switching Protection Pressure **OFF** disables the pump protection. The alert is always active, and if it appears, other internal functions (pH control, ORP, remanent injection) will stop.

Pump power:

This is a SPACE characteristic, the indication of the nominal power of the pump, or the average power in the case of a variable speed pump, allows the energy consumption to be estimated in the STATISTICS.

Determine speeds in the different modes:

Default Speed in 24/24H mode

- Cycle 1 speed
- Cycle 2 speed
- Cleaning speed 3

8.3 FILTER DATA

Configuring alerts and Filter backwash.

A well-maintained filter is essential for a clean and healthy pool. As the filter retains material from the water flowing through it, it gradually becomes clogged: The pressure increases and the water flow decreases. Eventually the efficiency of the filtration decreases and the filter needs to be cleaned. Without cleaning, energy is wasted, chemical consumption increases and the water may turn green.

These settings allow you to configure the alert that will warn you when the filter needs to be cleaned. when the filter needs to be cleaned. For compatible filters (sand filters or For compatible filters (sand filters or multimedia filters) this menu also configures the automatic filter cleaning.

Filter Type

Define which type of filter is used:

- Press: the filter is AFTER the pump, working on pressure
- Suction: The filter is BEFORE the pump, working on suction

Depending on filter type, pressure settings below are affected.

Cleaning pressure:

Set the pressure at which an automatic cleaning cycle should be initiated. This also defines the limits of the pressure gauge. (Pay attention to the pump curves. With steep curves, the cleaning pressure can be higher than the normal pressure than with flat curves (the circulation capacity decreases less). With FlowVis and the manometer you can set the cleaning pressure perfectly.)

Example:

Pressure with flushed filter and speed 2 at desired circulation capacity: 10m³/h => 0.7 bar pressure
Generate in the return line with a valve back pressure until circulation drops by 20 – 30%: So, 8 – 7m³/h
Read how much pressure is on the display (exam. 1.0 bar). Use this as flushing pressure.
The cleaning pressure should be between 0.2 – 0.4 bar higher than the normal pressure at speed 2.

Number of days between cleanings:

Set the maximum numbers of days between 2 Clean Filter alerts.

If the periodic cleaning is not required, select 0 days.

Cleaning time:

When periodic cleaning is activated set a time at which the reminder to clean filter will be sent. If cleaning mode = Auto, a filter cleaning will be performed. If periodic frequency is set to 0 days, Time is preset to ---:--.

Automatic Cleaning valve:

- None
- Besgo

FILTER DATA	
> Type	: Press
Pressure	: 1.00 Bar
Frequency	: 0
Time	: 22:30
Auto Valv	: None
Cleaning	: Manual
Pump_Run	: NO
Backwash	: 80 sec
Rinse Valv	: None
Rinse	: 20 Sec
Suction	: None
Clean Via	: Surface
APF Dosing	: NO
Priming	: OFF
SELECT QUIT	

Filter Cleaning:

Filter cleaning can be either:

Inhibited: SPACE will not perform - and will not allow you to perform - filter cleaning. If cleaning is required by pressure or frequency, a message will alert you to the need to clean the filter. This setting should be used for cartridge filters or if cleaning is not desired. The Wash and Rinse positions of the multiport valve are not allowed.

Manual: SPACE will not perform - but will allow you to perform - filter cleaning. If cleaning is required by pressure or frequency, a message will alert you to the need to clean the filter. You can then initiate a cleaning cycle by pressing "clean filter now" from the filter sub-menu.

Automatic: SPACE will perform the cleaning automatically when required by pressure or frequency.

Keep the pump running – while switching besgo valve:

If selected, the pump will remain in operation when operating the BESGO cleaning valve. By default, the pump is stopped each time the valve is operated.

Text:	Pump run
Default:	NO
Entries:	NO; YES

Backwash :

Displayed if **CLEANING: AUTO** or **CLEANING: MANUAL**.

Set the desired backwash duration in seconds. Refer to the filter manual for recommended backwash duration. Only available if a cleaning valve is present.

Text:	Backwash
Default:	80 seconds
Entries:	10 – 600 seconds

Rinse valve:

The rinsing valve (Besgo 3 ways) is optional and is only really needed if you have a Layer of activated carbon on the filterbed

- None
- BESGO

It is not configured by default (factory setting).

If configured it is controlled by **Aux13**

(which makes it impossible to set up a counter-current jetstream).

Text:	Rinse Valv
Default:	None
Entries:	None; BESGO

Rinsing time :

Set the desired rinse duration, in seconds, during an automatic cleaning cycle. It is usually 20 to 60 seconds, the larger the filter, the longer the rinse time.

Text:	Rinse
Default:	20 seconds
Entries:	10 – 180 seconds

Suction valve:

A BESGO 3-way valve can be installed in front of the pump. That makes a lot of sense especially for overflow pools and saves a lot of energy. The evaporation in the channel is greatly reduced. When bathing the pool is overflowing at speed

At night and when not in use you are in the Eco-Mode.

The valve is controlled by Aux4. Piping principle page 42 + 43.

Valve will be controlled by Aux4.

- None
- BESGO (standart)

Text:	Suction
Default:	None
Entries:	None; BESGO

Clean (Backwash) via:

- Surface (Skimmer or buffertank)
- Bottom (Bottom drains) = (standart)

Text:	Clean via
Default:	Surface
Entries:	Surface; Bottom

APF (flocculant) Dosing

Flocculant (APF) can be injected continuously when the filtration is on (pump started and water goes through the filter).

To ensure automatic injection, declare "APF dosage=YES".

It will be controlled by the Aux8 output provided the SPACE Extension Module is present.

Text:	APF Dosing
Default:	NO
Entries:	NO; YES

Priming (APF pump test)

Commanding priming **ON** will activate the Aux channel for 60 seconds allowing the feeder pump to prime. Priming is stopped when quitting the menu or **after 60 seconds**

Text:	Priming
Default:	OFF
Entries:	ON; OFF

8.4 Configuring Inputs

There are 10 input channels if SPACE Extension Module
Each entry is configured independently.

Be careful! Use only approved external equipment with a potential-free circuit.

Input Type

Text:	None
Default:	Available
Entries:	Available; Thermostat AntiFrz; Disinf Consumables; pH Consumables; Consumables; Pool Cover; Salt System; Filtration Start; Filtration Stop; JetStream; Flow Switch; Flooding; FloodingStop; Low FAC Flow; ACO (Oxidant) consumab; APF (Flocc) Consumables; Electrolysis prot; Overflow; Open Cover; Close Cover

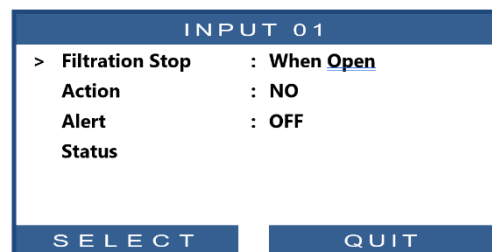
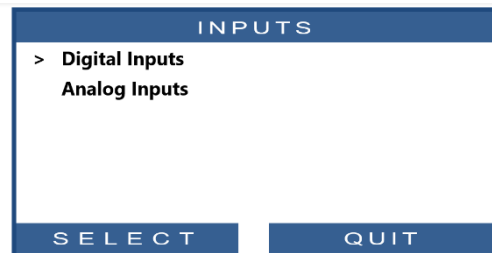

Sense of action

The sensor action configures whether the alert action is taken when the circuit is closed (direct action) or open (reverse action). For example:

Text:	Action
Default:	When CLOSED
Entries:	When CLOSED; When OPEN

- If the thermostat contact closed indicates a freezing risk, choose **"Action when CLOSED"**.
- If the level detection senses that consumables are low by opening the contact in the switch, choose **"Action when OPEN"**.

Configures whether the alert is triggered when the circuit is closed (direct action) or open (reverse action).

Alert

Determines whether an Alert is associated with the sensing on the input or not. If **YES**, when input is detected, an alert will be displayed on screen and send to server (if connected to internet)

Text:	Alert
Default 1:	NO
Default 2:	NO
Entries:	NO; YES



Analog inputs

FlowVis flowmeter

Select the diameter (or type) of flowmeter installed, so that the mA to >m3/h conversion is done at the correct scale.

Model	Description	Diameter ("SCH80)	Min flowrate (m3/h)	Max flowrate (m3/h)
FV-15	FlowVis 1.5" for piping	D 50mm	2.2	182.2
FV-2	FlowVis 2.0" for piping	D 63mm	2.2	25
FV25	FlowVis 2.0" for piping	D 75mm	2.2	25
FV-3	FlowVis 3.0" for piping	D 90mm	15.6	5.5
FV-4	FlowVis 4.0" for piping	D 110mm	34	102.2
FV-6	FlowVis 6.0" for piping	D 160mm	68	227
FV-8	FlowVis 8.0" for piping	D 200mm	136	409

The read value is displayed in the FlowVis menu and on the filter backwash screen while backwash is in progress. The low alarm will only be issued if the flow rate during filter cleaning is too low.



Scan QR Code to learn how to connect digital Sensor to FlowVis

8.5 Factory settings

Besides the described settings below, displays the firmware version which may be required for support.

FW Version Menu

Viewing the firmware version

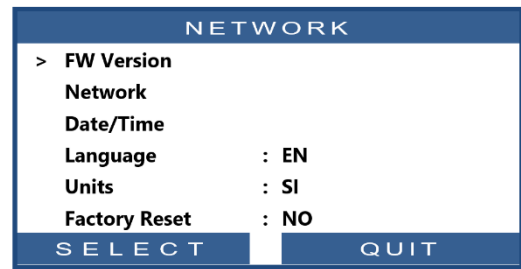

Network menu

- MC:** MAC address, used to link the unit to an account on the Dryden SPACE Server
- IP:** IP address of SPACE on the local network
- MSK:** Subnet mask
- DNS:** IP address of the Domain Name Server.
- GTW:** IP address of the gateway (router) on the local network
- SVR:** IP address of www.dryden-space.com server

Date/Time menu

Set date and time.

Language

Select SPACE language

Units

Select SPACE display units

Factory Reset

Selecting and confirming resets all defaults and calibrations, requiring reprogramming and pH sensor calibration check.

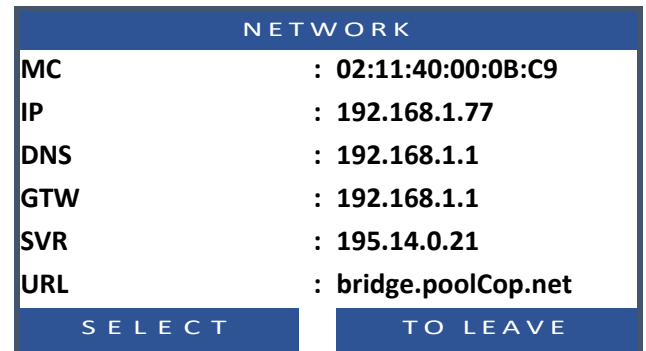

8.6 Equipment

8.6.1 Pool Cover



WARNING:

Remote control of a Pool Cover can cause severe injury.
The user MUST ALWAYS have the pool in direct view when manoeuvring the cover.
The pool must be monitored at all times during the operation of the Pool Cover to ensure that no person is in the pool or enters the pool

Only available with SPACE Extension Module Plug-in

Installed:

If **INSTALLED: YES**, SPACE will be able to control the Pool Cover opening and closing.
 If set to **NO**, the Pool Cover (if any) will be operated manually.

Text:	Installed
Default:	NO
Entries:	YES; NO

Pool Cover:

Opens and closes the pool cover. To function properly, the pool cover must be installed on **Aux14** (Open command) and **Aux15** (Close command).

Opening Setting (Aux14 Settings)

When Pool Cover function is installed, **Aux14 (Open command)** is preconfigured in pulse mode with 2 minutes pulse duration. These settings can be changed from this view. Duration should be long enough to allow full cover operation from closed to open.

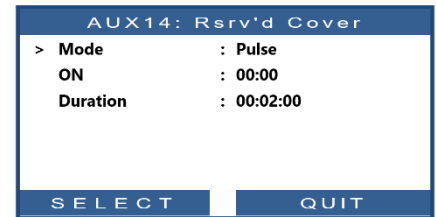

Closing Setting (Aux15 Settings)

When Pool Cover function is installed, **Aux15 (close command)** is preconfigured in pulse mode with 2 minutes pulse duration. These settings can be changed from this view. Duration should be long enough to allow full cover operation from open to close.

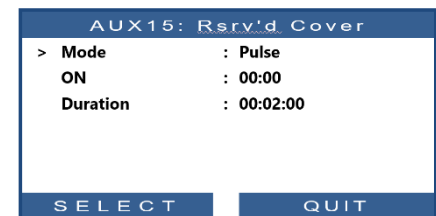

Duration :

Define the opening and closing times to allow full operation;
 The times must be longer than the operating time of the cover.

Input :

Select the detection direction and alarm according to the signal from the cover control

Position Setting (Input 10)

When Pool Cover function is installed, **IN 10** is preconfigured for Pool Cover 'closed' position sensing. The settings can be changed from this view, in particular, one can decide to get an alert (or not) when cover is not detected closed.

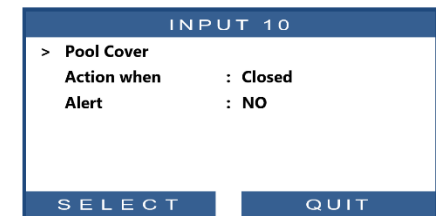

8.6. Equipment

8.6.2 JetStream

Allows control of a counter-current jetstream pump.
To work properly, the pump must use Aux13 as a control.
Input 9 is the pneumatic push button to start the pump from the pool.
The jetstream can only work if the pool cover is open
(when a pool cover is declared).

Installed

If **INSTALLED: YES**, SPACE will be able to control a JetStream via the push button in the pool or via a direct command.

If set to **NO**, the JetStream (if any) will be operated manually.

Input

Select the input, the direction of detection and the alarm according to the signal coming from the push button.

Setting Command (Aux13 Settings)

When JetStream is installed, Aux13 (Pump command) is preconfigured in pulse mode with 60 minutes pulse duration. These settings can be changed from this view.

Setting Push Button (IN 9 settings)

When JetStream is installed, In(9) is preconfigured to receive the push button action. The settings can be changed from this view.

Operating time:

After pressing the button, the Jetstream will run for the set time and then stop.
Pressing the push button during the running time stops the pump immediately.

Note:

If the pool has a cover and the cover is detected closed by SPACE, then the JetStream pump is forced OFF for safety reasons. JetStream pump is only allowed to run when the cover is not closed

Note:

The push button pneumatic signal must be converted into an electrical contact outside SPACE using a pressure switch. The contact will be then connected on In(9).

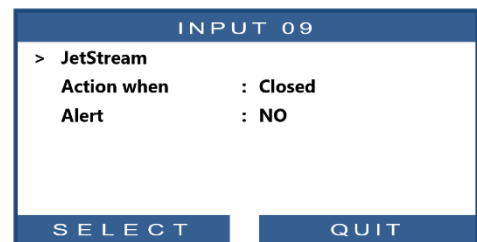
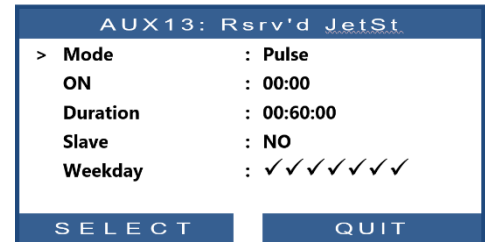
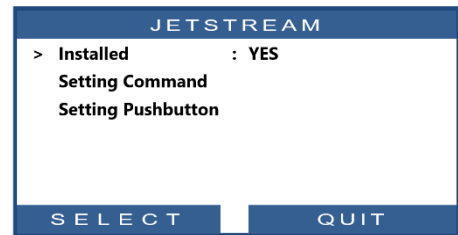

9.0 SPACE CLOUD

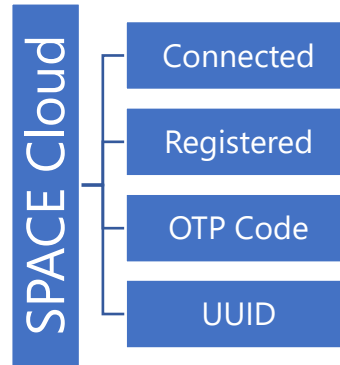
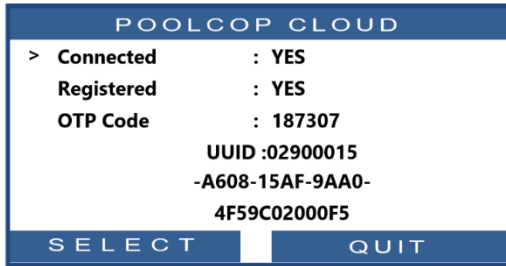

Get Internet to SPACE

The DCCU is equipped with an RJ45 connector.

Bringing the network to the DCCU:

- Best is to have an Ethernet cable (mini Cat4) connecting the router to the SPACE DCCU by RJ45.
- On the DCCU side, Insert the RJ45 cable as shown in the picture.
- Check that access to internet is available at the cable end. You may need a laptop to check this.
- Connect the end of the RJ45 cable to the network so as to establish a connection via the internet box.
- Start SPACE (if it was stopped).



RJ45 Connector for Ethernet

If RJ45 connection is not possible, an optional SPACE GSM Router can be purchased from Dryden Aqua (Ref 44104)



Independent GSM Router

To check connection.

SPACE Cloud Menu => Connected

Display the connection status to SPACE Cloud.

YES: Connection to the cloud is established

NO: Connection not established.

Text:	Connected
Default:	Read only
Values:	YES; NO

Create a User Account and connect SPACE to your pool

1. Note of the following codes

OTP Code

One-time password used to associate the SPACE with a swimming pool.
This code will be requested during the registration process.

Text:	OTP Code
Default:	Read only
Values:	6 digits number

UUID Code

Unique Device Identifier

This code will be requested during the registration process.

Text:	Code UUID
Default:	Read only
Values:	32 alphanumeric

2. Go to www.dryden-space.com

- ❑ Connect to the site www.dryden-space.com
- ❑ On the home page, select **"Sign up"**.
- ❑ Select the type of profile required:
 - **"Personal Account"** will allow you to manage only your own pool as a final customer.
 - **"Pro Account"** will allow you to manage your clients' pools.
- ❑ Complete all the information required in the form, in particular:
 - Supply a valid email address; this will be used to identify the client and to route email alerts.
 - Tick the boxes to agree to terms of use, and optionally **"I agree to received data from SPACE"** to receive newsletters.
- ❑ Follow instructions on the screen to connect SPACE to your pool. **UUID code will be requested.**

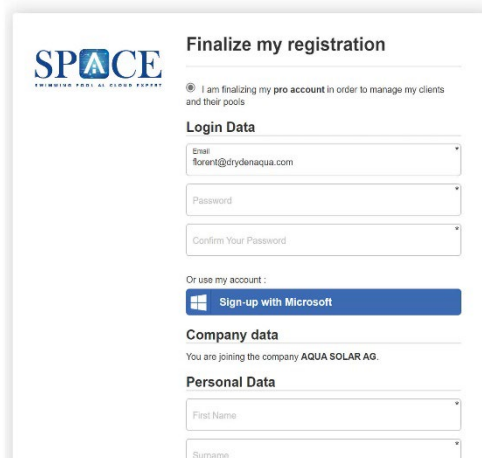
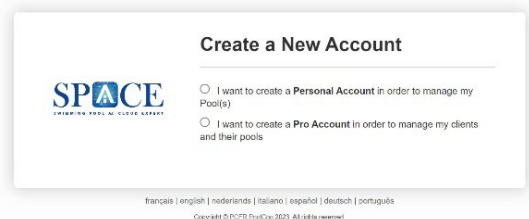
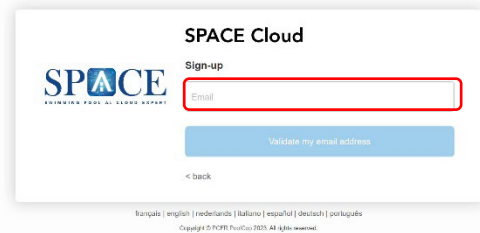
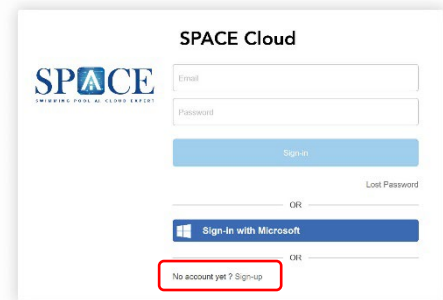
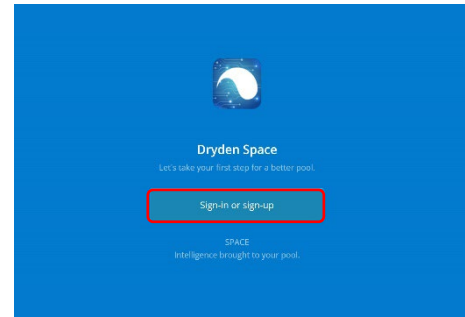

To check if you are well registered.

SPACE Cloud Menu => Registered

Once SPACE has been correctly paired with a pool,
The status is **YES**.
If it is not associated,
The status is **NO**.

Text:	Registered
Default:	Read only
Values:	YES; NO

10.0 Circulation Modes

Mode ECO

Eco mode is intended for channel pools or spas with a channel only. Space must have the cover configured. In the case of indoor pools, the Eco Mode can be used when pool cover is configured (even if there is none) and there is an electrical bridge (wire) installed, that configures the cover as closed.

CIRCULATION MODES	
> ECO Mode	: OFF
Setpoint	: 20.0°C
Bottom Cycle	00:00=>00:00
Surface Cycles	00:00=>00:00
	00:00=>00:00
	00:00=>00:00
	00:00=>00:00
	00:00=>00:00
SELECT	QUIT

This mode saves on heating costs. When it is cold and when the pool is not in use, the water is circulated via the main drains and will not flood. The gutter stays dry and will have zero evaporation. The gutter is typically 20% of the pool surface. As a result, in outdoor pools and even in indoor swimming pools the evaporation in the channel is eliminated and with this enormous energy savings achieved.

In addition, the filter can be backwashed directly from the pool (via the main drains). As a result, the balance tank can be dimensioned correspondingly smaller, which saves costs and space. Small investment => big savings

- Installation on infinity pools :

The valve must be installed that in the rest position (no pump running) the valve is such, that the water is sucked via the bottom drains. When the suction valve is powered, the water will be drawn from the buffer tank and the pool will overflow. This configuration prevents the buffer tank from overflowing in the event of a power failure.

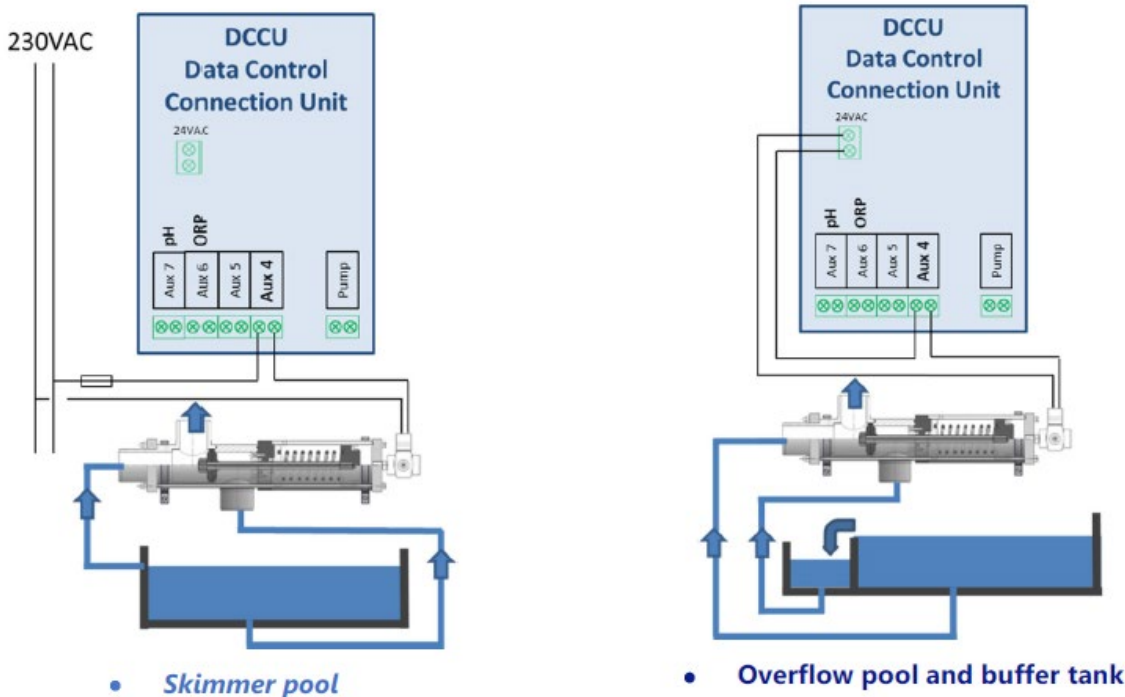

Connecting BESGO for pump suction in 230VAC

skimmer pools

In skimmer pools, a suction valve allows backwashing directly from the pool. This is important for skimmer pools with high water levels equipped with slim skimmers and for small pools and especially whirlpools with big sand or AFM-filters

It is not set to **Aux4** by default (factory setting).

It can be configured from the "Filter Data" menu by declaring "Suction=BESGO".

Priorities

The 3-way-besgo-suction-valve has several uses that may require a different position. In case of conflict on the requested position, the priority rules are evaluated in the following order:

1 During a cleaning (and flushing), the valve is oriented according to the position chosen in the filter data:

- a. Bottom.
- b. Surface.

2. If the water level is low, the valve faces the bottom.

3. During a surface cycle, the valve is oriented towards the surface (overflow pools only).

4. If the water level is very high, the valve is oriented towards the surface.

5. If ECO mode is activated and only for overflow pools with closed cover:

- a. If the $T^{\circ} \text{Air} > \text{Set point} + 1^{\circ}\text{C}$, the valve is oriented towards the surface.
- b. If the $T^{\circ} \text{Air} < \text{Setpoint}$, the valve is oriented towards the bottom.

6. If an overflow request is activated via the BP, the valve is oriented towards the surface.

7. During a bottom cycle, the valve is oriented towards the bottom (overflow pools only).

8. If none of the above cases apply, then:

- a. Pool with skimmer, from the surface.
- b. Overflow pool:

- Open cover = from the surface (overflow-mode)

- Closed cover = Position according to air temp. (as described in point 5).

The position of the valve will be determined by the first of the 8 rules to be checked. Subsequent rules will not be taken into account as long as the current rule remains true.

For example, if a surface cycle is in progress (rule n°3) and the level becomes low, then rule n°2 takes over and rule n°3 is not processed as long as the level remains low.



Scan QR code to learn more about Besgo 3-way valves

Besgo 3-way valves

For Energy saving mode in overflow pools, automatic rinsing and more.

11.0 Schematic diagrams

SKIMMER POOLS

SPACE with DAISY+ (DA-GEN) SCHEMATIC DIAGRAM

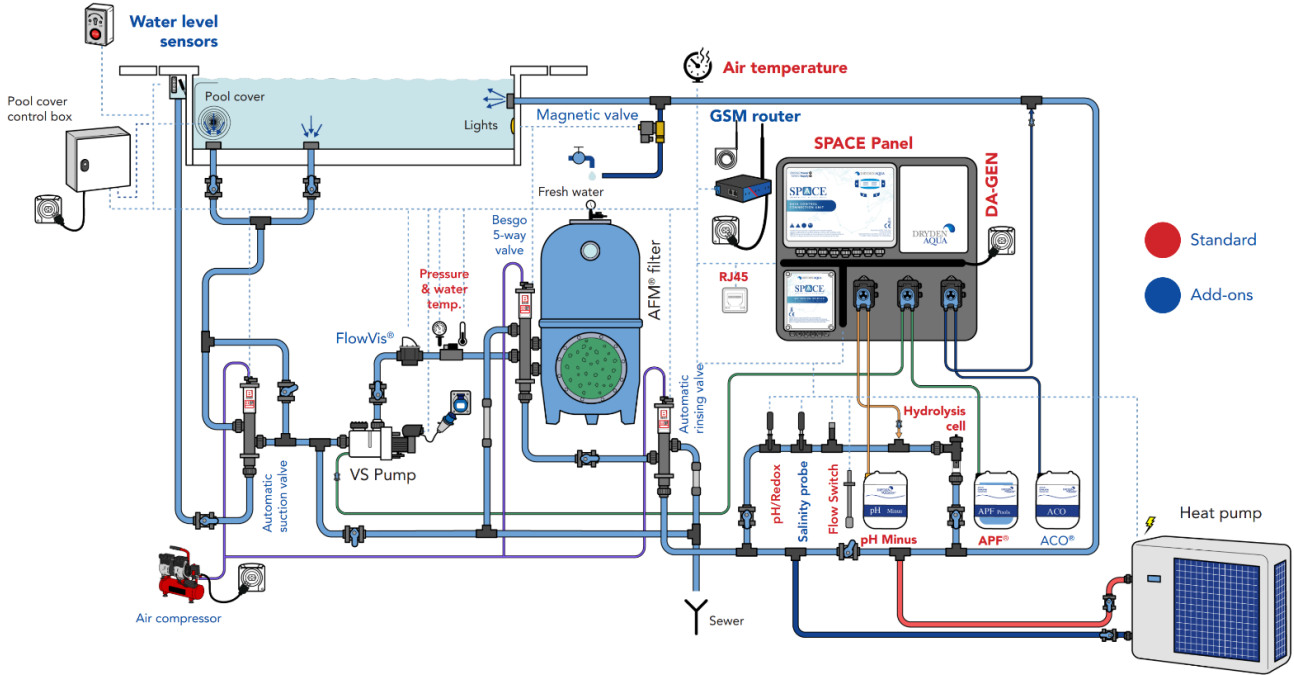

SPACE with DAISY (Liquid Chlorine) SCHEMATIC DIAGRAM

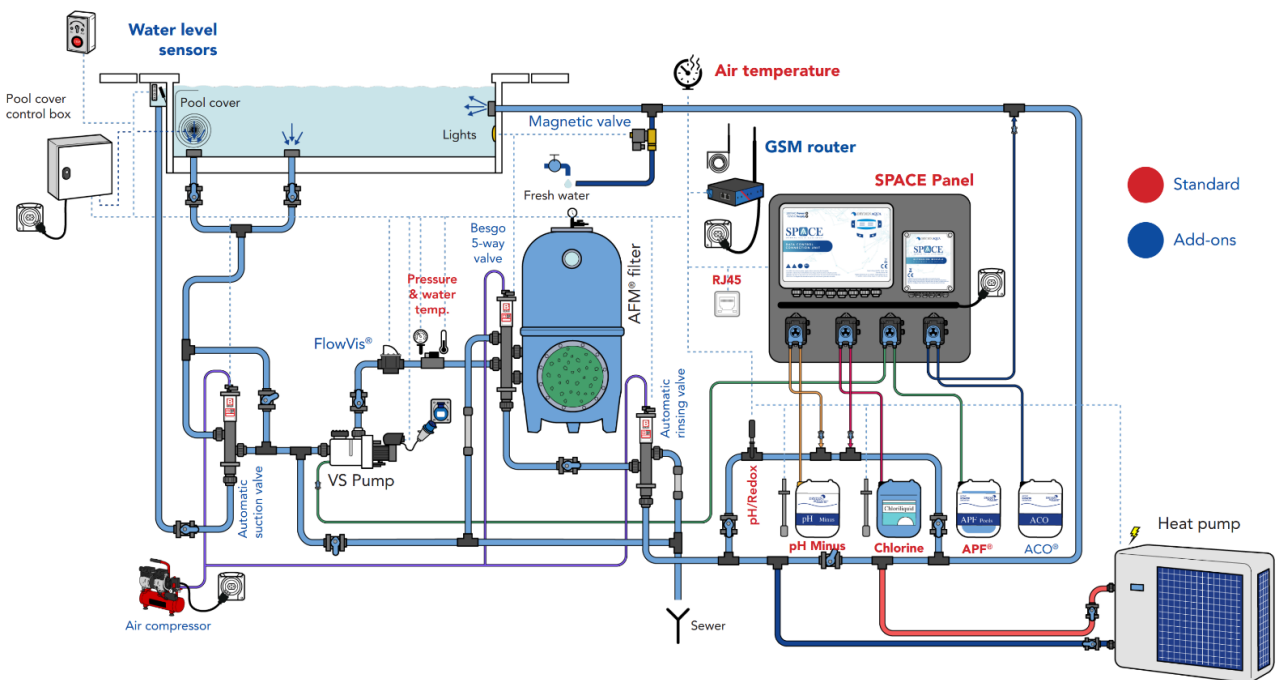

OVERFLOW POOLS

SPACE with DAISY+ (DA-GEN) SCHEMATIC DIAGRAM

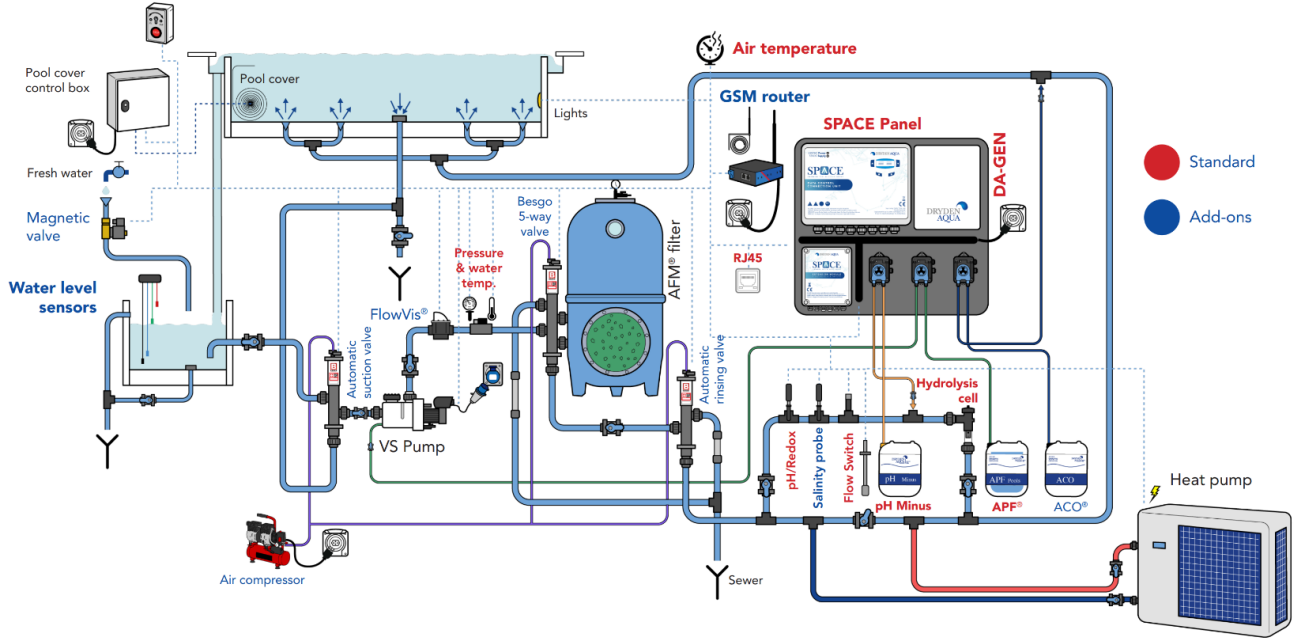

SPACE with DAISY (Liquid Chlorine) SCHEMATIC DIAGRAM

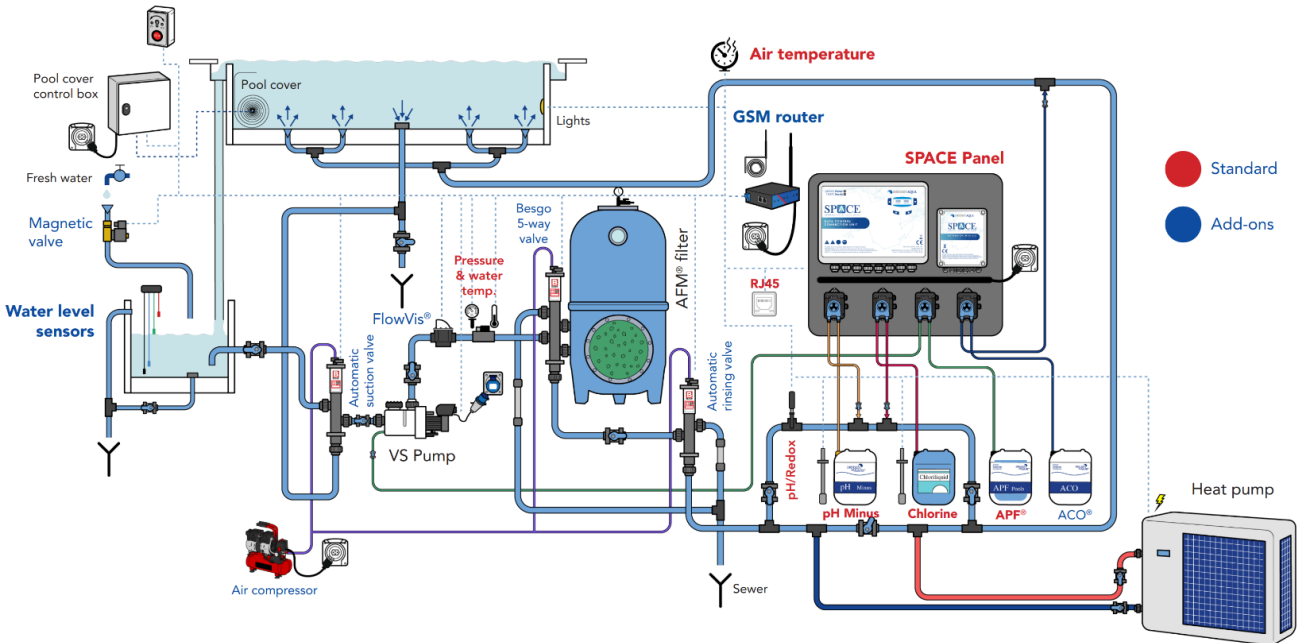

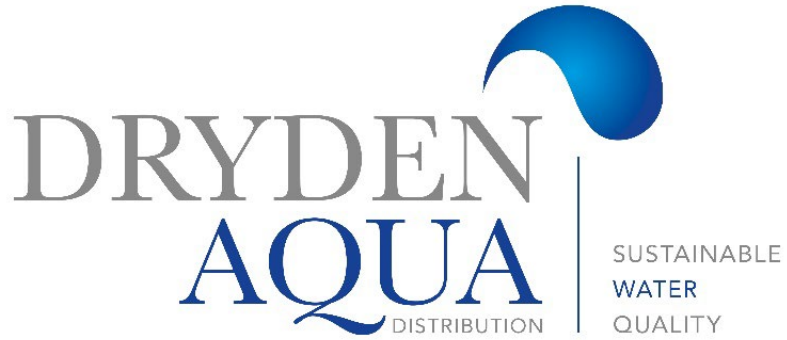

SPACE

SWIMMING POOL A.I. CLOUD EXPERT



Wiring
Schematics