

2019
English

Operating Instructions

AS Control Plus



AS Control Plus

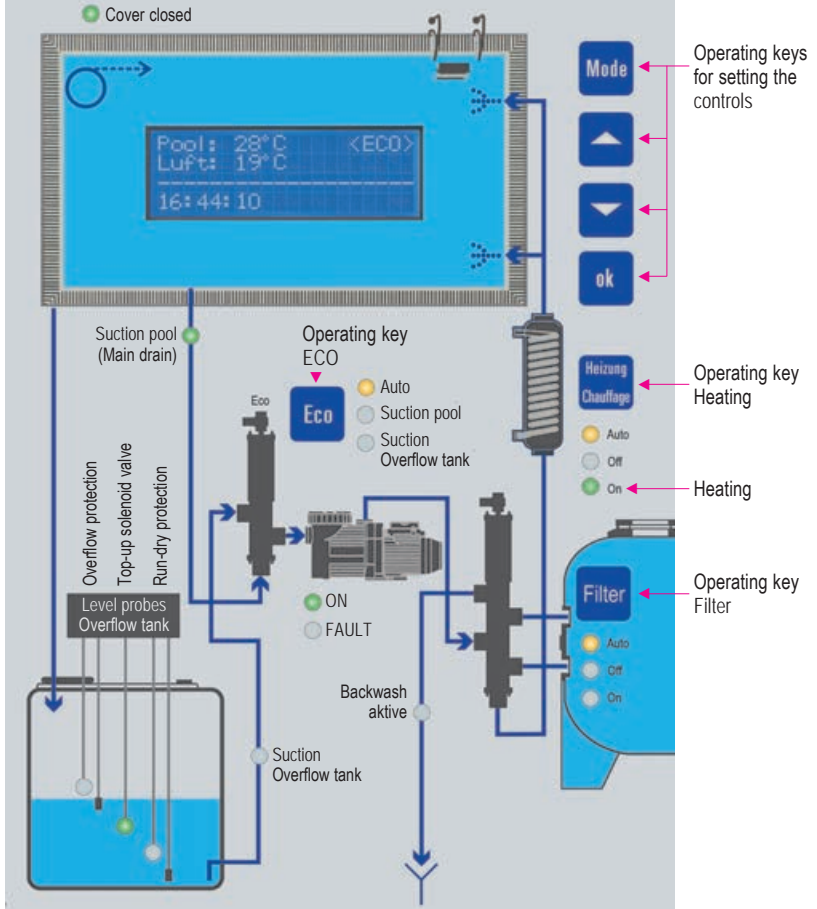

Introduction

Thank you for choosing the AS Control Plus an innovative control system incorporating a microprocessor. It will dramatically improve the energy efficiency of overflow / infinity swimming pools and avoid unnecessary energy losses. On our test Pool (50 m² at 30 °C water temperature) in Switzerland we were able to demonstrate an energy saving of more than 20'000 kW (equivalent to 2'000 litres of oil) in a six-month period (May to October).

Contents:	Page
Comments on energy efficient controls	4
Control keys: ECO, Filter, Heating	5
Menu functions: Menu language; filter pump menu	6
Heating menu	6, 7
Backwash menu	7
Overflow tank menu; ECO menu	8
Configuration menu	9
Important informations	10
<hr/>	
Wiring diagram AS Control Plus	11
with Badu Prime, Delta, Profi and Alpha Pump	12
with Pentair IntelliFlow VSD and control IntelliComm II	13
with Pump UWE EO PM	14
with frequency converter AS	15
with frequency converter Invertec	16
Menu diagram	17

The AS Control Plus includes:

1. Comments on energy efficient controls
2. Backwash and rinse controls or control of the compressor
3. Heating controls with frost protection, priority and delay-slop safety
4. Level control of the overflow tank
5. Control of overflow tank (backwash from the pool or the overflow tank)
6. Energy efficiency control (economy or overflow Operation)
7. Shortcut for starting a backwash and changing the heating setpoint
8. All data for the previous ten-month period are stored. These can be downloaded onto a PC for analysis.
9. Optional flow control with a paddle switch

Technical data:

Connectors:	78 connectors for inputs and outputs
Relays:	13 relays
Electrical input:	14 VA
Electronic motor protection:	for 3-phase, max. 8 amps per phase
Fuse:	4 per 10 amps
Display:	4 layer multilayer
IP Protection:	casing: IP 65
Memory card:	for data storage and evaluation via PC
Temperature probe:	laser-trimmed semiconductor with +/-1 % accuracy
Water and air:	temperature probes are volt-free

Installation

- The ASCP must be installed in a place free from humidity
- Wiring of components must be carried out according to the ASCP wiring diagram
- The regulations of the local electricity authorities must be observed

Comments on the energy efficient control (Overflow and economy mode)

The most original concept of the AS Control Plus is the temperature-dependent switching between overflow and economy (also known as normal operation) modes of operation and the resultant energy savings.

1. Overflow operation:

In the so-called overflow operation (normal operation) the water is circulated via the **overflow channel → overflow tank → pump → pool → overflow channel**. The hydraulic operation is optimal because the pool water is drained via the overflow. However, with high water temperatures and low air temperatures there is a large amount of heat loss (evaporation, convection). During operation, with the pool covered open, the pool water has to be circulated via the overflow.

2. Economy mode:

In so-called economy mode water is drained directly from the pool (i.e. from one or more drains). **Pool → pump → pool**. Thus the water no longer flows via the overflow. The heat loss is reduced considerably. Economy mode is best suited to periods of cold weather or during a pool heat-up period. During periods of use the pool should always be run in overflow mode for reasons of security and hydraulic efficiency.

Limits of liability:

We do not assume any liability for the layout or safety of the drainage system. The correct layout of the drainage system is the responsibility of the installation company. The local regulations concerning the safety of drainage systems must be observed. If there are no specific regulations we always recommend that drains with hair-trap security be fitted. As well as installing at least two drains with a distance of 1,5 m between them. The suction speed of the drains should not exceed 1,2 m/s. The ideal position for drains is where the bathers cannot come into contact with them. **CAUTION:** incorrect drain installation can cause death.

Pump switched off:

If the pump is switched off or there is an electricity cut, the Besgo valve will be in economy mode (drain directly from the pool). In this way the pool will not be emptied by mistake. The water cannot be fed back into the overflow tank via jets and the filter. That would lead to a loss of water, if the water level in the collection tank were to rise so high that the water flowed over the edge of the buffer tank.

As additional security we recommend the installation of a non-return valve into the inlet jet system as well as the incorporation of a forced start (5th probe) in the collection tank.

Limits of liability:

We do not assume any liability for the cost of loss of water, which is caused by the failure, and/or misuse of the AS Control Plus or the Besgo valves.

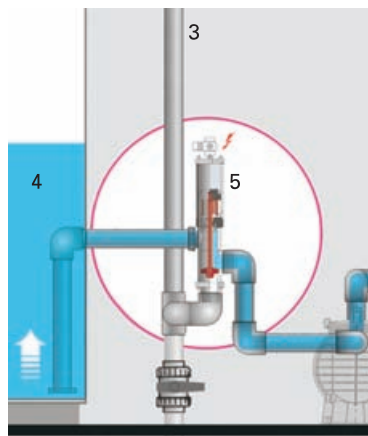

Overflow operation

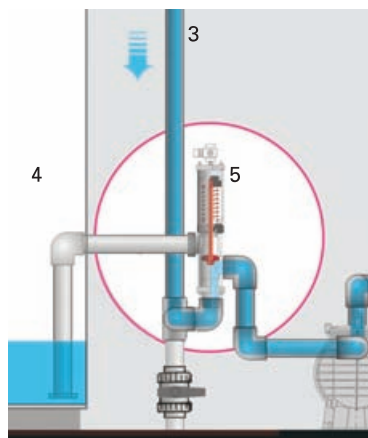

Economy mode

Overflow operation (normal operation)

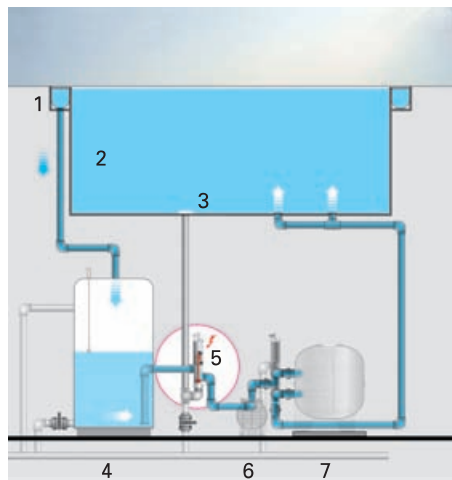

1 Overflow channel
2 Swimming pool
3 Main drain

Economy mode

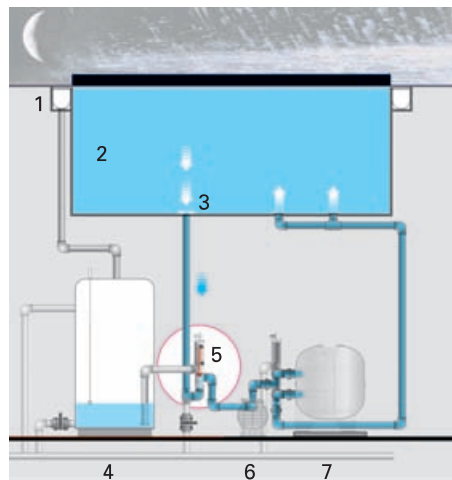

4 Overflow tank
5 Besgo 3-way valve
6 Pump
7 Filter

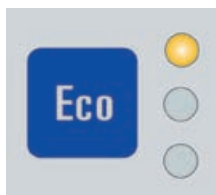

ECO switch:

There are three options:

1. Auto operation:

In this position, as a function of air and water temperatures, it is determined whether drainage will take place directly via the pool (economy mode) or via the overflow channel. As soon as the pool cover is opened, the system goes into overflow mode. (The limit switch must be connected to terminals 71/72)

2. Main drain operation (economy mode):

The Besgo valve is always in the economy mode and drainage is via the main drain irrespective of temperature and whether the pool cover is open or closed.

3. Overflow tank operation:

The pool is always drained via the overflow channel – irrespective of temperature and whether the pool cover is open or closed.

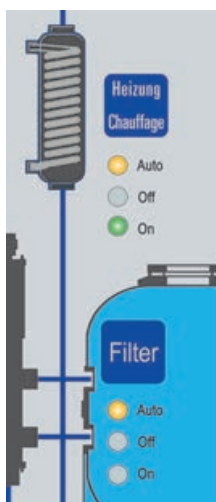

Heating key:

Auto: heating operates according to the programmed filter time

Off: heating is switched off

On: if this light is lit the heating is operating. The set temperature has not yet been reached.

Filter key:

Auto: filter operates according to the programmed filter time

Off: filter is switched off

On: filter operates permanently

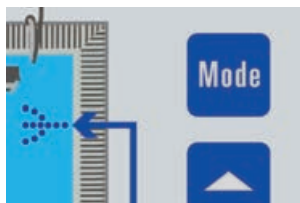

By pressing the **MODE** key you enter the menu.

The additional functions are indicated in the menu with the → Symbol.

MENU LANGUAGE: (factory setting is German)

Press the OK key and you can then select by means of the arrow key between German, French, Italian, English and Spanish..

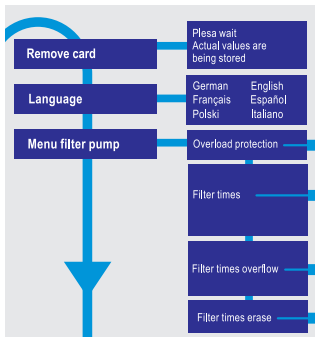

FILTER PUMP MENU

OVERLOAD PROTECTION: (factory setting is OFF)

Press the OK key and you are then in the overload protection menu where you can first select if the overload protection is to be switched on or off. If the OP is switched on, by pressing the OK key the motor current will be measured, displayed and saved for the connected pump.

If you decide to connect a different pump to the **AS Control Plus**, you will need to determine the current for the new pump. You can exit the display of the current by pressing the MODE key. Once you have determined the current, you can select the tolerance level to determine the percentage overload at which the overload protection is triggered and the filter pump switches off (typically the tolerance is set to 15 %).

If the contact of the flow switch opens, the pump stops after a delay of 20 seconds.

FILTER TIMES (Factory settings: 08.00 to 09.00)

By pressing the OK key you can select up to five filter times per day, when the water will be channelled via the overflow. This is necessary since the water level is only controlled in the collection tank and not in the pool.

CAUTION: You must circulate the water via the overflow for at least 30 to 60 minutes per day. Only in this way can you measure and control the water level (the measurement takes place in the overflow tank).

Additionally, the correct water flow (via the overflow channel) will be re-established by entering the times for the overflow operation, which will ensure proper circulation within the pool. With public pools, we recommend switching to over-flow operation between one and two hours before the pool is occupied in order to ensure the correct water flow.

CAUTION (Warranty exclusion)

Damage which is caused by too low a water level (e.g. burnt-out solar cover) will not be covered by us.

CANCELING FILTER TIMES: by pressing the OK key, all filter times can be cancelled.

During this process you will be asked to confirm whether you really mean to cancel all filter times. You confirm by pressing the OK key.

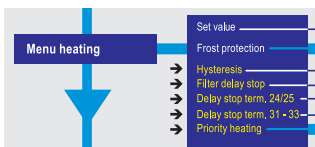

HEATING MENU:

SET VALUE: (factory setting 25 °C)

By pressing the OK key the set point of the water temperature can be selected by means of the arrow keys between 1 °C and 40 °C.

Shortcut: Press the Filter button for 4 seconds to start a backwash

FROST PROTECTION: (factory setting OFF)

By pressing the OK key the frost protection can be selected as ON or OFF by means of the arrow keys. In the ON position you can select by means of the OK key at which temperature (-50 °C to +20 °C) the frost protection switches on the filter pump. The adjustable hysteresis (temperature difference between ON and OFF) gives the switch-off signal. Additionally a collective alarm can be interconnected. If you have a heating system connected you can select at which pool water temperature the heating should switch on and off.

- HYSTERIS (factory setting 0.5 °C)
By pressing the OK key the hysteresis can be adjusted between 0.1 °C and 5 °C by means of the arrow keys. Hysteresis means the number of degrees Celsius, which separate the switching ON and OFF.
- FILTER DELAY STOP (factory setting 3 minutes)
By pressing the OK key the filter run-on time can be adjusted between 1 and 200 minutes by means of the arrow keys. The run-on time can help to stop a build-up of heat in the system by ensuring that the filter pump continues to run after the heating has been switched off. If a run-on time has been set via terminals 24/25 and/or 31-33, this time will be added to the run-on time for the filter.
- DELAY STOP TERMINAL 24/25 (factory setting 0 minutes)
By pressing the OK key the filter run-on time can be adjusted between 1 and 200 minutes by means of the arrow keys.
- DELAY STOP TERMINAL 31-33 (factory setting 0 minutes)
By pressing the OK key the filter run-on time can be adjusted between 1 and 200 minutes by means of the arrow keys.
- HEATING PRIORITY (factory setting OFF)
The heating can also be switched on outside the filter operation times. By pressing the OK key the heating priority can be switched off or set to a temperature difference of between 1 °C and 10 °C for heating priority.

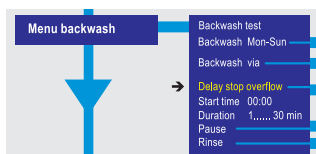

BACKWASH MENU TEST BACKWASH

By pressing the OK key a backwash cycle can be started manually. The progress of the backwash cycle can be observed on the display. Shortcut: Press the Filter button for 4 seconds to start a backwash.

BACKWASH: (factory setting Friday)

By pressing the OK key the backwash can be completely switched off or the day of the week changed or an interval of 1 to 30 days between backwash cycles chosen by means of the arrow keys.

BACKWASH VIA: (factory setting overflow tank)

By pressing the OK key you can select, by means of the arrow keys, whether the backwash takes place via the overflow tank or the main drain.

- **DELAY STOP VIA OVERFLOW** (factory setting 30 minutes)

After every backwash there is a compulsory flow via the overflow channel. The time is adjustable between **0 and 200 minutes**.

START TIME (factory setting 10.00 am)

By pressing the OK key you can select the time at which the backwash starts.

DURATION: (factory setting 4 minutes)

By pressing the OK key you can select, by means of the arrow keys, the duration of the backwash between 1 and 30 minutes.

PAUSE (factory setting 30 seconds)

By pressing the OK key you can select whether you want to pause between each individual step. The duration of the pause can be set, by means of the arrow keys, to between 30 and 200 seconds.

RINSE (factory setting OFF)

Press OK. With the arrow buttons you can turn rinsing ON/OFF or select compressor. The duration of the rinsing can be set between 1 and 200 seconds. If you choose the setpoint „compressor“ you can connect a compressor instead of a backwash valve. It will turn on before and during the backwash (Pause = Lead time). The compressor will be activated as well during overflow mode.

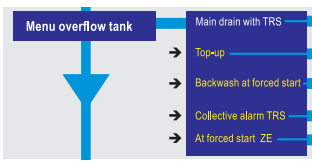

OVERFLOW TANK MENU:

MAIN DRAIN AT DRY RUN PROTECTION (Factory settings: OFF)

The «Besgo» valve switches to main drain to avoid stopping the filtration pump because dry running (empty overflow tank).

By pressing the OK key you can select this function ON and OFF.

→ TOP-UP (factory setting 90 minutes)

By pressing the OK key you can select whether the top-up with fresh water should be time-controlled or whether the top-up is switched ON or OFF. If the top-up is time-controlled, you can set the time limit for the top-up between 1 and 999 minutes. If the time limit has been reached and the water level has not reached its set height, there is a problem with the top-up system. The top-up switches off and the override alarm is triggered.

→ BACKWASH WITH FORCED START (factory setting OFF)

Here you can select automatic backwash in the case of forced start. In this way you can avoid too much water from draining away needlessly via the safety overflow. The water can then be used again for another backwash. Backwash can also be useful when heavy rain causes the overflow channel to be switched on, thus causing an unnecessary waste of energy. The delay time for the backwash can be set between 1 and 200 minutes.

→ GENERAL ALARM: RUN-DRY PROTECTION (factory setting OFF)

By pressing the OK key you can select whether to trigger the general alarm in the case of a run-dry situation. If you activated the general alarm, you can select a delay time of between 0 and 200 minutes. When this time has expired, the general alarm is triggered and a warning text appears in the blue display panel.

→ COLLECTIVE ALARM: FORCED START

By pressing the OK key you can select whether to trigger the collective alarm in the case of a forced start situation. If you activated the general alarm, you can select a delay time of between 0 and 200 minutes. When this time has expired, the general alarm is triggered and a warning text appears in the blue display panel.



ECO PROGRAMME MENU:

ECO PROGRAMME MODE

(factory setting: set temperature 20 °C, hysteresis 1 °C)

→ By pressing the OK key you can select whether overflow operation is triggered when a specific ambient air temperature is reached or when a specific temperature difference between ambient air and water temperatures is reached.

a) Set temperature: until the set temperature for air is reached, the system remains in economy mode (no current to the Besgo valve - drained directly from the pool). Only when the set temperature has been reached does the Besgo valve switch to overflow mode. Setting 5 °C to 40 °C. When solar covers are being used we recommend the use of the set temperature. The set temperature should be set no higher than 20 °C. At a temperature of 20 °C in the shade, there is considerable solar gain from the cover which is stored up under the cover in economy mode. Temperatures under the cover can reach as much as 50 °C and more. This heat accumulation must be dissipated via the overflow channel.

b) Temperature difference: You can set a temperature difference of between +10 °C and -10 °C. For example, if a temperature difference of +2 °C is set, then the Besgo valve switches to operation via the main drain if the air temperature is 2 °C higher than the water temperature. If a temperature difference of -2 °C is set, then the Besgo valve only switches if the air temperature is 2 °C lower than the water temperature.

CAUTION: (liability exclusion)

Some pool manufacturers (polyester, liner) limit their warranty to use at temperatures of 30 to 35 °C. Potential damage to such pools or their covers is not covered by us.

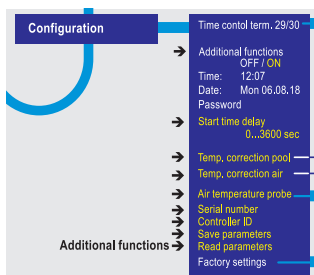

MENU CONFIGURATION:

Time control or air purge Clamp 29/30:

By pressing the OK key you can set up the potential-free contacts on terminals 29 and 30 according to the wiring diagram with a time interval of between 1 and 30 days or with a weekly time programme. You can select up to nine operation times between 00:00 and 23:59. This contact can be set up in such a way that it is only closed when in addition to the time programme, the Filter pump, dosing pump or heater is running. The operating times of the time programme can be erased and re-programmed.

When choosing „air purge“ you can air purge the filter before backwashing with a solenoid valve.

ADDITIONAL FUNCTIONS:

By pressing the OK key, the additional functions from the settings menu can be hidden. The operator cannot access them any more. The additional functions remain as set and are active although they are not visible in the menu.

TIME OF DAY: By pressing the OK key you can select, by means of the arrow keys, the current time. Even after switching off the AS Control Plus the time is preserved by means of a back-up CR2032 battery.

DATE: By pressing the OK key you can select, by means of the arrow keys, the current date. Even after switching off the AS Control Plus the date is preserved by means of a back-up CR2032 battery.

PASSWORD: (default: 0.0.0.0)

By setting a password the menu is only accessible after entering the correct password
0.0.0.0 means no protection

→ START DELAY: (factory setting 10 seconds)

By pressing the OK key you can select a start time delay between 0 and 3600 seconds. The start delay is always active if: the power supply connected, after a failure of the power supply, when the filter pump starts. By means of the start delay the outputs for heating, regulation and forced start are locked.

→ POOL TEMPERATURE CORRECTION: By pressing the OK key you can adjust by means of the arrow keys the actual pool water temperature shown in the blue display by up to +10 °C to -10 °C. This fine adjustment is useful when there is a difference between the measured and actual pool temperature due to the positioning of the temperature probe.

→ AIR TEMPERATURE CORRECTION: By pressing the OK key you can adjust by means of the arrow keys the actual air temperature shown in the blue display by up to +10 °C to -10 °C. This fine adjustment is useful when there is a difference between the measured and actual pool temperature due to the positioning of the temperature probe.

→ TEMPERATURE PROBE AIR: (factory settings: ON). By pressing OK you can enable or disable the indication of the value.

→ SERIAL NUMBER: By pressing OK the Serial number will be indicated

→ CONTROLLER-ID: Press OK to see the Controller ID.

→ SAVE PARAMETERS: By pressing OK all adjusted parameters will be written to the SD-memory card.

→ READ PARAMETERS: By pressing OK all saved parameters will be copied to the AS-Control Plus.

FACTORY SETTINGS: By pressing the OK key you can enter the factory settings menu. If you answer the questions by pressing the OK key, all the values which you have set can be reset to the original factory settings. All set values are stored electronically and can be recovered even after a power failure. The date and time are stored by means of a back-up battery which has a life of three to four years. By removing the four screws on the front panel you can access this battery without any special tools.

IMPORTANT INFORMATION:

Terminals 45/46. A manual switch ON/OFF-I can be connected to these two terminals. By switching on the manual switch the filter pump is switched on and operation via the overflow channel is initiated. It is advisable to mount this manual switch near the pool.

Terminals 52/53. These terminals can be used in conjunction with an air-conditioning unit. When the contacts are closed, circulation is via the main drain.

Terminals 71/72: These terminals can be connected with the swimming pool cover. If these contacts are closed the ECO control (if set to AUTO) decides whether water will be circulated via the main drain or the overflow buffer tank. The pre-set filter times remain. The potential-free contact of the limit switch for the pool cover must be wired as follows: pool cover on the pool = closed limit switch contact.

Priorities

The overflow filter time always has priority over other actions. This means that when the unit is operating via the main drain (in economy mode) and the overflow filter times are active, the controls switch to normal operation.

With the same objectives, the following priorities are active:

Im gleichen Sinn sind folgende Prioritäten vergeben:

- > 1. Overflow filter time
- > 2. Manual switch (terminals 45/46)
- > 3. Unit switch (auto/ main drain/ overflow tank)
- > 4. Cover limit switch (terminals 71/72)
- > 5. Eco-programme (set temperature and differential temperature)

FROST MONITOR

The frost protection mode only allows the heating to start, if the filter pump started over the air temperature.

Hysteresis

Example:

Set temperature 28 °C / hysteresis 1 °C / actual temperature 20 °C

In this example the heating will heat until 28 °C and then switch off. The heating will only switch on again when the water temperature drops below 27 °C. In this way you ensure that the temperature can only vary between 27 °C and 28 °C.

Wiring diagram

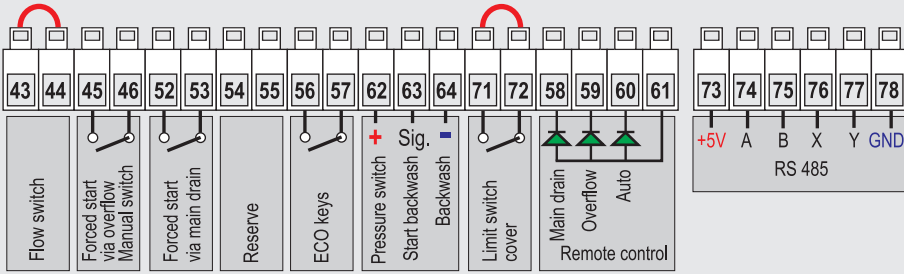

Bridge work in delivery

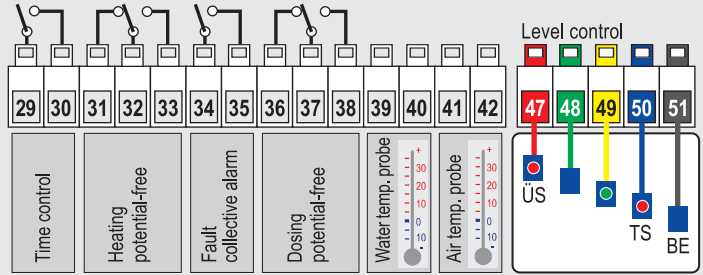
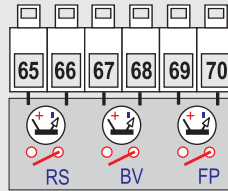

Overflow tank

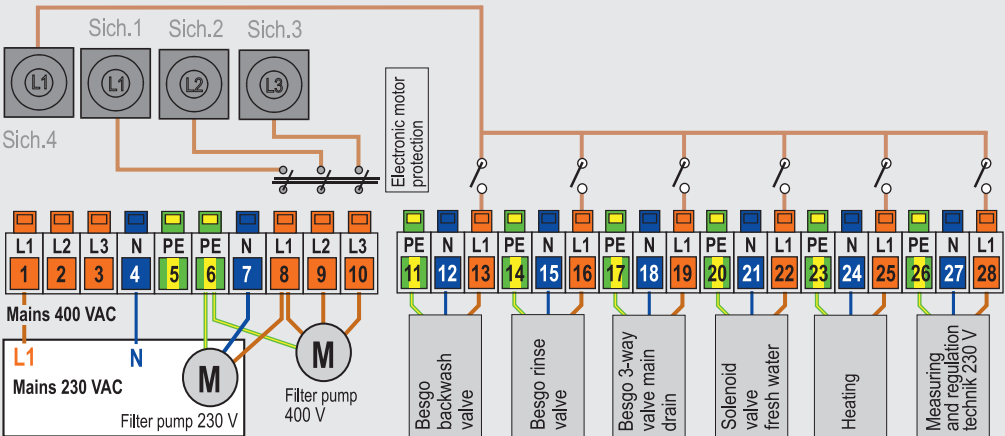

Caution: Only 1 filter pump can be connected (230 VAC or 400 VAC).

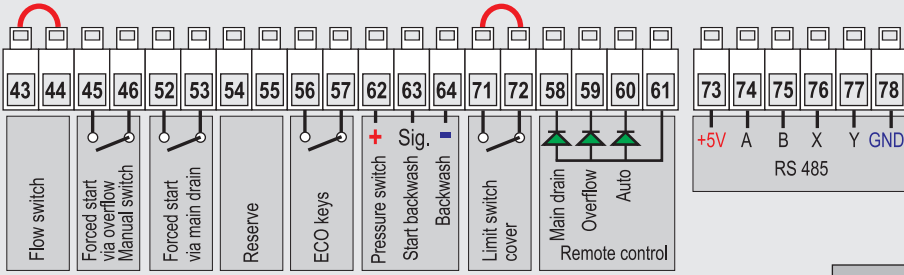

 Bridge work in delivery

with Speck Badu Prime

Art. No. 034110

with Speck Badu Delta

Art. No. 034113

with Speck Badu Profi

Art. No. 034101

with Speck Badu Alpha

Art. No. 034112

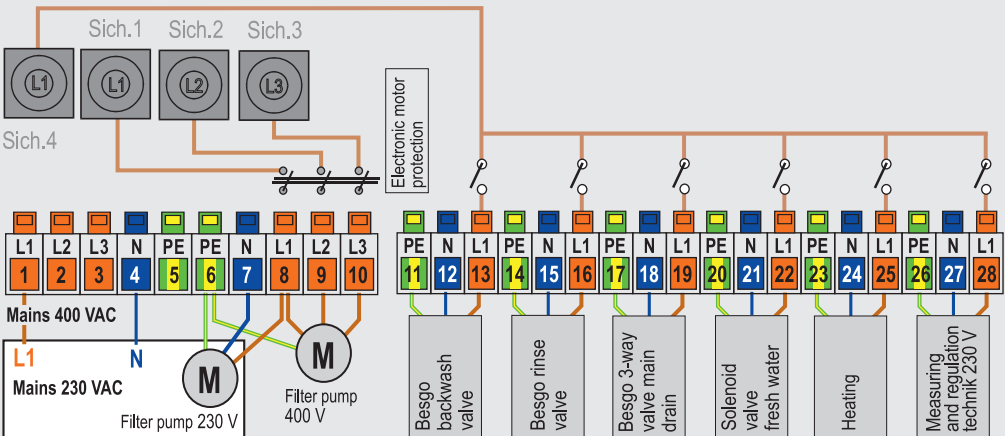
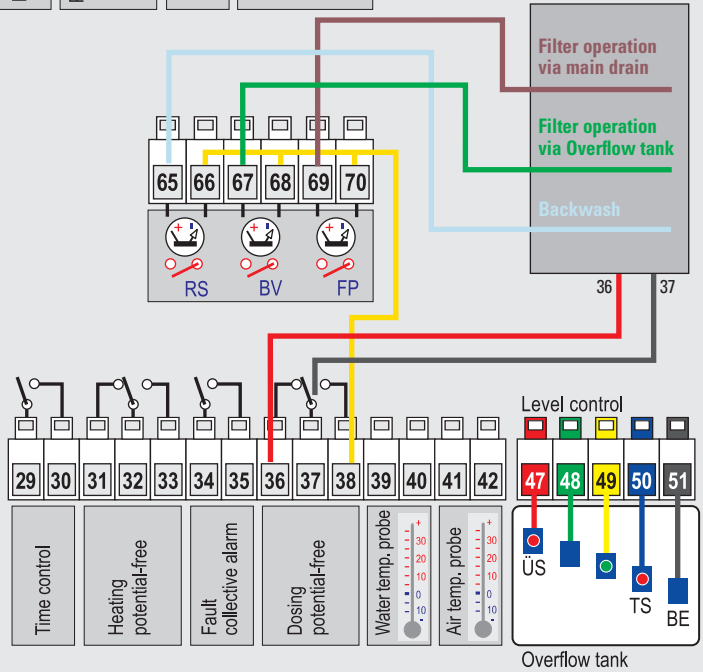

Wiring diagram

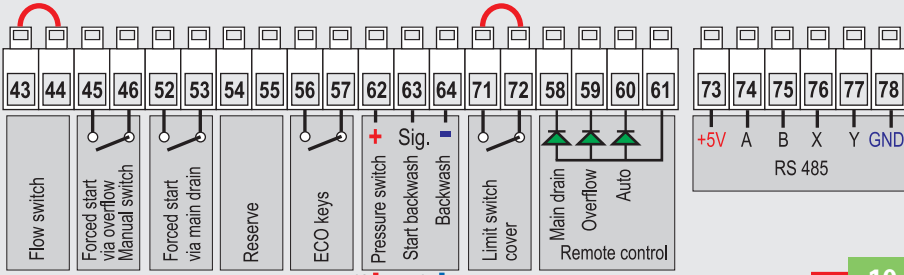

Bridge work in delivery

with Pentair IntelliFlow VSD and control IntelliComm II

Art. No. 034001
Art. No. 034006

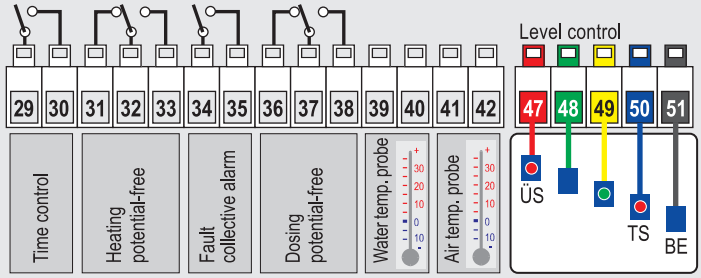
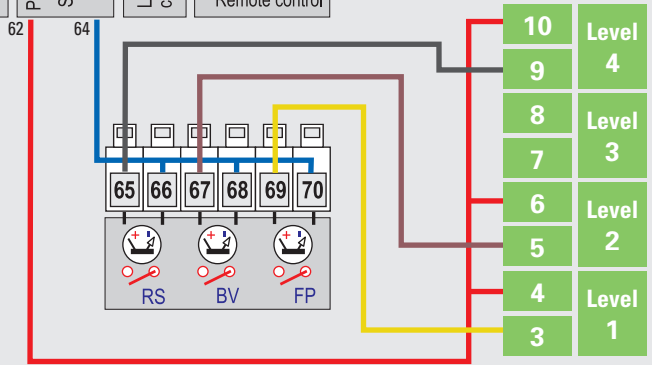

Overflow tank

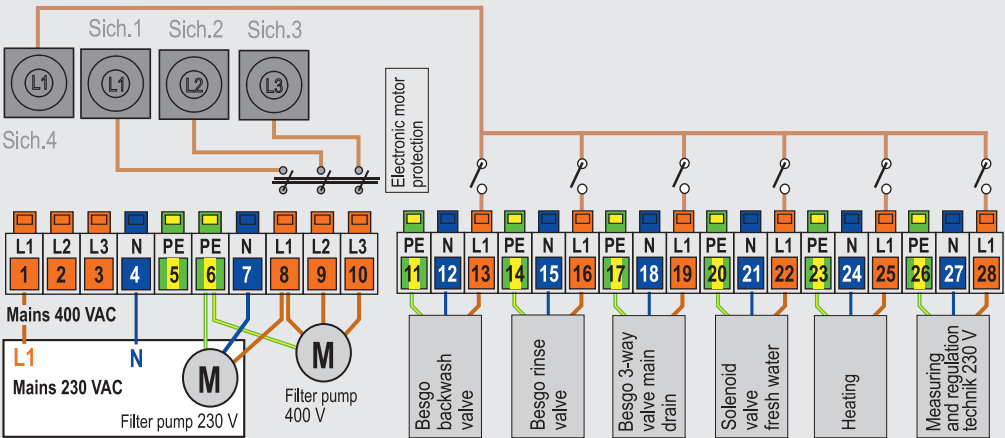

Wiring diagram

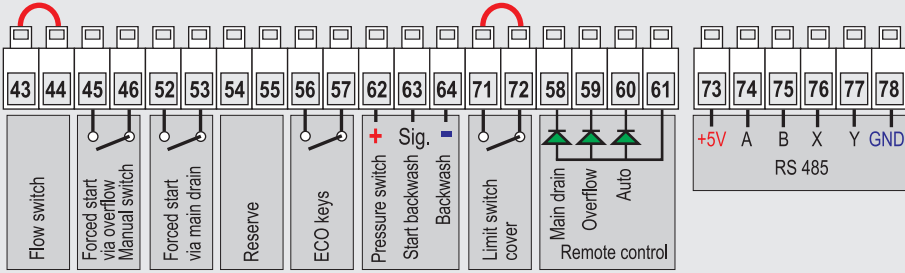

Bridge work in delivery

with pump UWE EO PM

Art. No. 037000

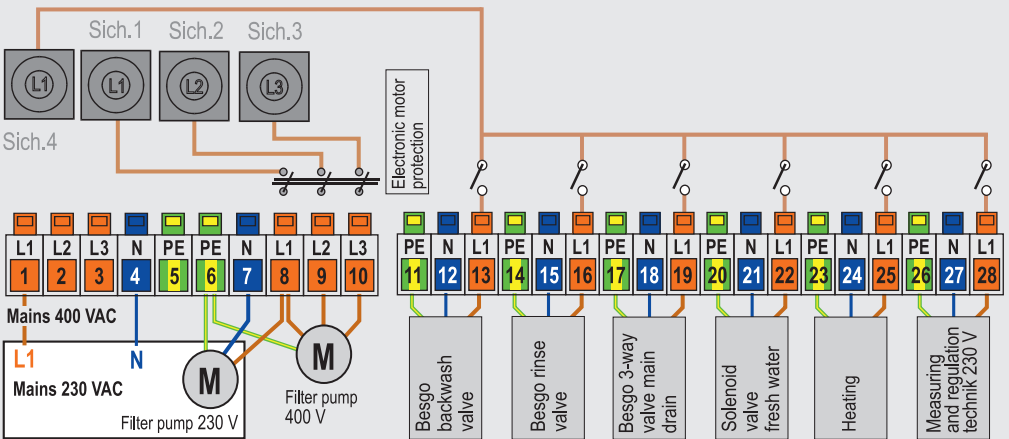
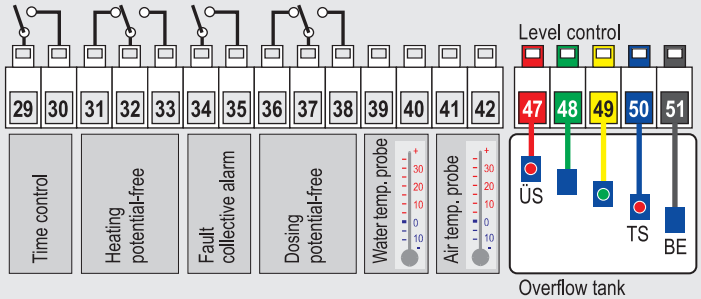
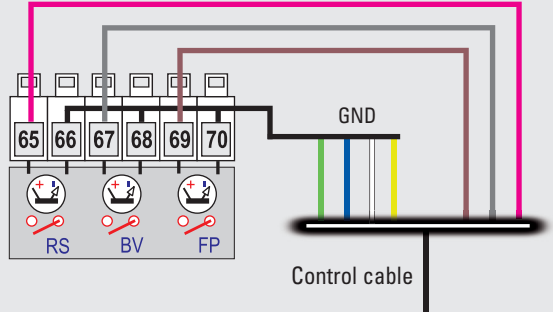

Wiring diagram

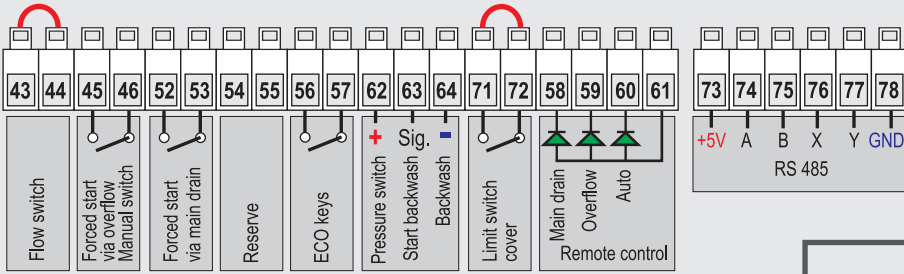

Bridge work in delivery

with frequency converter AS (ATV 212)

Art. No. 036120 - 036129

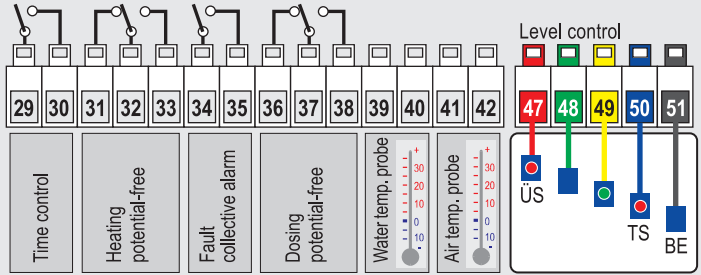
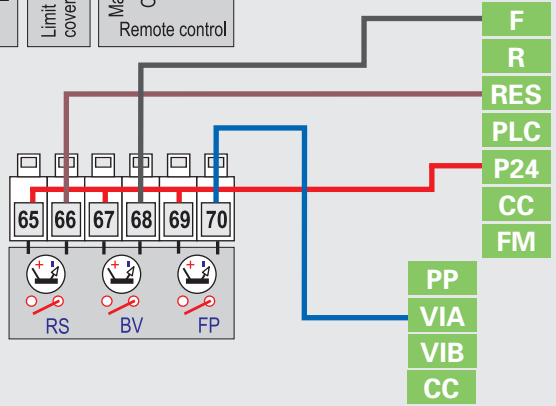

Overflow tank

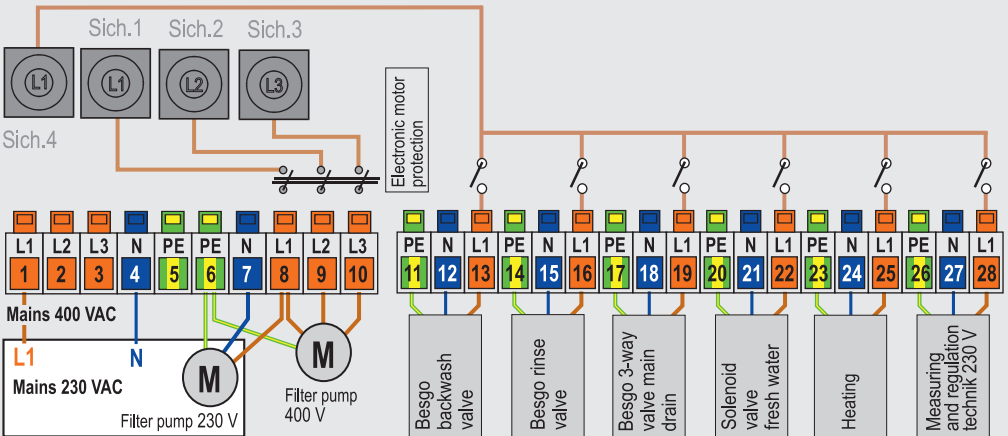

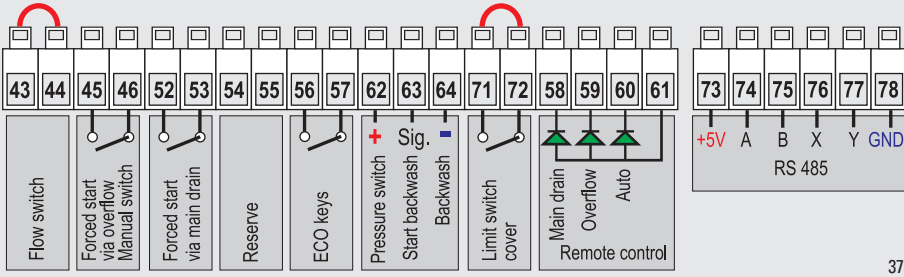

 Bridge work in delivery

with frequency converter
Inverter Optidrive E2

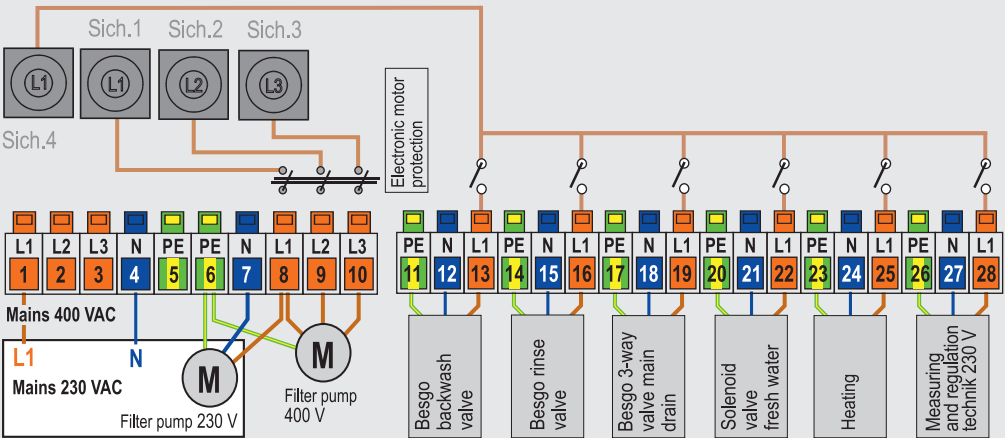
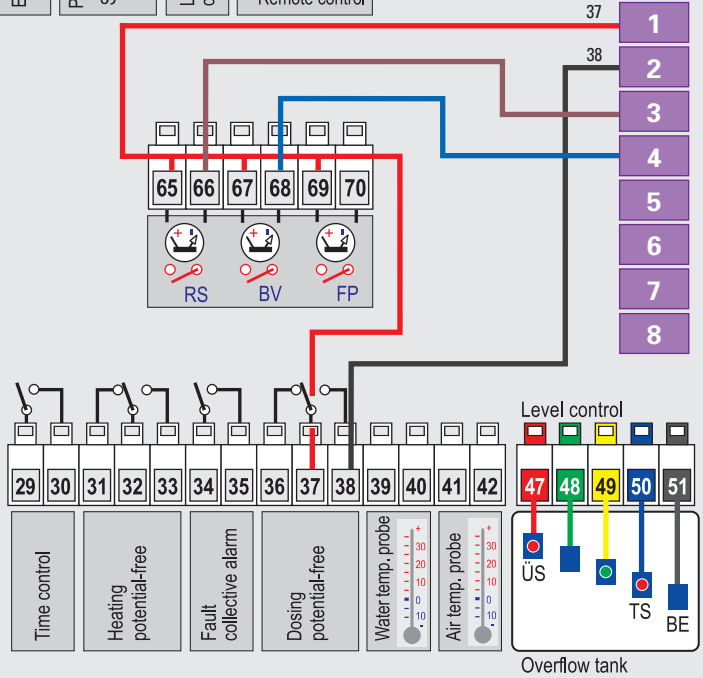

Menu layout with

→ additional functions

